

Dimensions Multi-turn actuators with ACVExC actuator controls (also for fieldbus & HART)

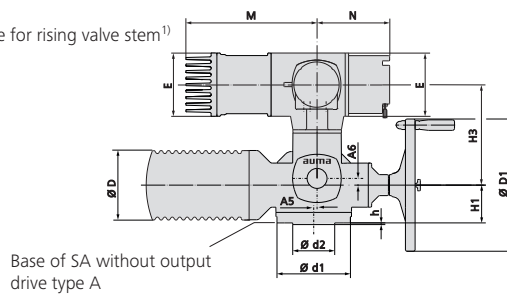

Option KES:
Ex plug/socket connector with terminal blocks

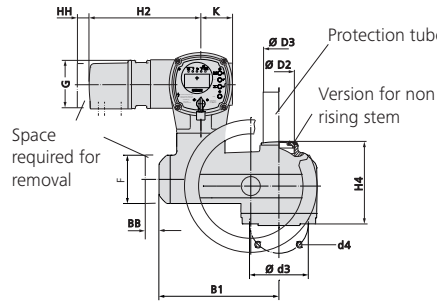
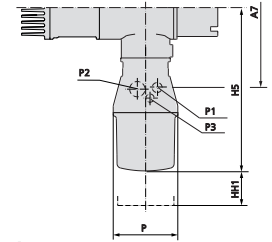

Valve attachments according to EN ISO 5210, DIN 3210, DIN 3338
For dimensions see overleaf

Handwheel shaft

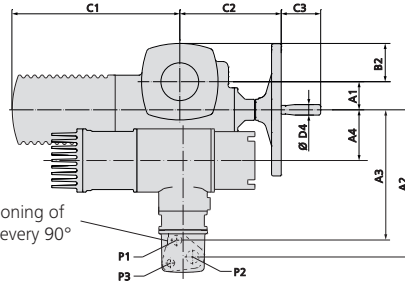
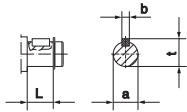

Possible positioning of plug cover at every 90°

Option KPH:
Ex plug/socket connector with screw-type terminals

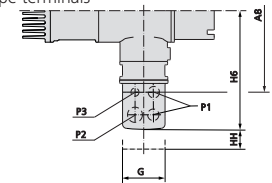

- 1) On explicit order only, in steps of 100 mm length each
- 2) Standard, other threads on request

Dimensions	SAVEx 07.2 SARVEx 07.2		SAVEx 07.6 SARVEx 07.6		SAVEx 10.2 SARVEx 10.2	SAVEx 14.2 SARVEx 14.2	SAVEx 14.6 SARVEx 14.6	SAVEx 16.2 SARVEx 16.2
	F07	F10 (G0)	F07	F10 (G0)	F10 (G0)	F14 (G1/2)	F14 (G1/2)	F16 (G3)
EN ISO 5210 (DIN 3210)	F07	F10 (G0)	F07	F10 (G0)	F10 (G0)	F14 (G1/2)	F14 (G1/2)	F16 (G3)
A1	40		40		50	67	67	80
A2	334		334		334	350	350	354
A3	294		294		294	310	310	315
A4	103		103		103	119	119	123.5
A5	-		-		-	8	8	15
A6	-		-		-	16	16	20
A7	287		287		287	287	287	287
A8	320		320		320	320	320	320
B1	245		245		255	293	293	311
B2	62		62		65	90	90	117
C1	268		268		283	389	389	432
C2	186		186		191	242	245	271
C3	63		63		63	94	94	94
Ø D	104		104		124	155	155	192
Ø D1	160		160		200	315	400	500
Ø D2	G 1¼"		G 1¼"		G 2"	G 2½"	G 2½"	G 3"
Ø D3	42 x 3.3		42 x 3.3		60 x 3.7	76 x 3.7	76 x 3.7	89 x 4.1
Ø D4	20		20		20	25	25	25
E	154		154		154	154	154	154
F	115		115		115	115	115	115
G	115		115		115	115	115	115
H1	78		78		80	90	90	110
H2	267		267		267	267	267	267
H3	235		235		235	251	251	255
H4	160		160		170	196	196	235
H5	404		404		404	404	404	404
H6	292		292		292	292	292	292
K	78		78		78	78	78	78
L	20		20		24	38.8	45.8	45.8
M	313		313		313	313	313	313
N	171		171		171	171	171	171
P	150		150		150	150	150	150
P1 ²⁾	M25 x 1.5		M25 x 1.5		M25 x 1.5	M25 x 1.5	M25 x 1.5	M25 x 1.5
P2 ²⁾	M32 x 1.5		M32 x 1.5		M32 x 1.5	M32 x 1.5	M32 x 1.5	M32 x 1.5
P3 ²⁾	M20 x 1.5		M20 x 1.5		M20 x 1.5	M20 x 1.5	M20 x 1.5	M20 x 1.5
BB min.	180		180		180	180	180	180
HH min.	60		60		60	60	60	60
HH1 min.	130		130		130	130	130	130
Ø a	20 d7		20 d7		20 d7	30 d7	30 d7	30 d7
b	6		6		6	8	8	8
Ø d1	90	125	90	125	125	175	175	210
Ø d2 f12	55	70 (60)	55	70 (60)	70 (60)	100	100	130
Ø d3	70	102	70	102	102	140	140	165
d4	4 x M8	4 x M10	4 x M8	4 x M10	4 x M10	4 x M16	4 x M16	4 x M20
h	3		3		3	4	4	5
t	22.5		22.5		22.5	33	33	33

We reserve the right to alter data according to improvements made. Previous documents become invalid with the issue of this document.

Dimensions Valve attachments according to EN ISO 5210, DIN 3338, DIN 3210

Stem nut

Type
EN ISO 5210 **A**
DIN 3210 **A**

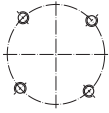

Arrangement of holes d4

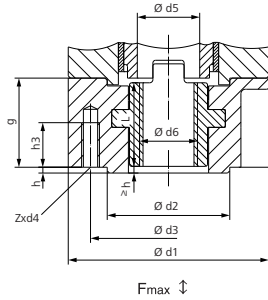

SA.../SAR...		07.2/07.6			10.2		14.2/14.6		16.2	
EN ISO 5210	DIN 3210	F07	F10	G0	F10	G0	F14	G1/2	F16	G3
F max. kN		40	70		70		160		250	
Ø d1		90	125		125		175		210	
Ø d2		55	70	60	70	60	100		130	
Ø d3		70	102		102		140		165	
d4		M8	M10		M10		M16		M20	
Ø d5			36		44		62		80	
Ø d6 max. 5)		Tr 26 ACME 1"	Tr 32 6)		Tr 40 ACME 1½"		Tr 55 ACME 2¼"		Tr 75 ACME 3"	
g		40	50		50		65		80	
h			3		3		4		5	
h3		12	15		15		25		35	
L		37.5	47.5		47.5		61.5		76.5	
Z			4		4		4		4	
Weight kg		1.1	2.8		2.8		6.8		11.7	
Bore with keyway according to DIN 6885-1		Ø d6 H9 max.	22	38		38	57		70	
Square		SW max.	20	32		32	42		on request	
Hexagon		SW max.	22	32		32	48		on request	

Special bores

Output drive sleeve 3)

Type
EN ISO 5210 **B1** d = d7 (b7/t7)
DIN 3210 **B** d = d7 (b7/t7)
EN ISO 5210 **B2** 1) d10 max. < d < d7
EN ISO 5210 **B3** d = d10 (b10/t10)
DIN 3210 **E** d = d10 (b10/t10)
EN ISO 5210 **B4** 1) d ≤ d10 max.

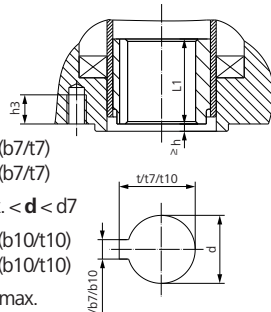

For missing dimensions, refer to type A

Special bores

Square	SW max.	22	30		30		45		60	
Hexagon	SW max.	24	32		32		50		on request	

Dog coupling 3)

Type
EN ISO 5210 **C** = d11
DIN 3338 **C** = d11

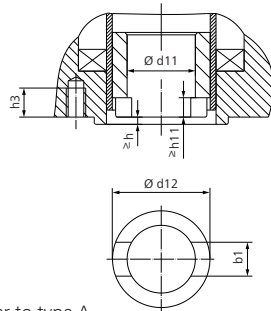

For missing dimensions, refer to type A

SA.../SAR...		07.2/07.6			10.2		14.2/14.6		16.2	
EN ISO 5210	DIN 3210	F07	F10	G0	F10	G0	F14	G1/2	F16	G3
b1 H11		14 4)	14		14		20		24	
Ø d11 H11		28 4)	28		28		38		47	
Ø d11 min.		–	20		20		30		40	
Ø d11 max.		–	42 2) 6)		42		60		80	
Ø d12		36.8	51.8		51.8		73.8		98	
h3		12	13		15		25		30	
h11		7 4)	7		7		8		10	

Shaft end

Type
EN ISO 5210 **D**
DIN 3210 **D**

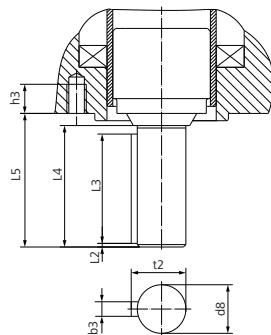

For missing dimensions, refer to type A

SA.../SAR...		07.2/07.6			10.2		14.2/14.6		16.2	
EN ISO 5210	DIN 3210	F07	F10	G0	F10	G0	F14	G1/2	F16	G3
Ø d8 g6			20		20		30		40	
b3 h9			6		6		8		12	
h3		12	13		15		25		30	
L2			1.5		1.5		2		3	
L3			45		45		63		80	
L4			50		50		70		90	
L5			55		55		76		97	
t2			22.5		22.5		33		43	
Weight kg			0.4		0.7		2		4.3	

1) Dimensions b, t depend on Ø d, refer to DIN 6885-1

2) For rising valve stem Ø d11 max. = Ø d5 of type A

3) Weight included in actuator

4) Dimensions neither complying with EN ISO 5210 nor with DIN 3338

5) Nominal diameter for trapezoidal thread Tr according to DIN 103 or ACME according to ANSI/ASME B 1.5

6) For stem protection tube made of PMMA max. Tr 30 or ACME 1½"

We reserve the right to alter data according to improvements made. Previous documents become invalid with the issue of this document.