

Spare parts list

auma[®]

Multi-turn actuators

SA(V)Ex 07.2 – SA(V)Ex 07.6

SAR(V)Ex 07.2 – SAR(V)Ex 07.6

Seals

KES d | KES

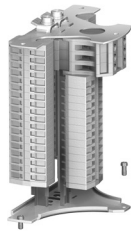
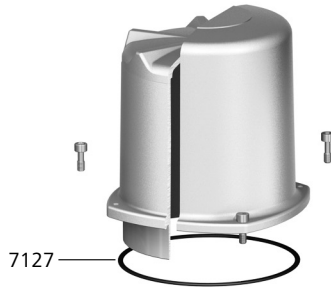

KP

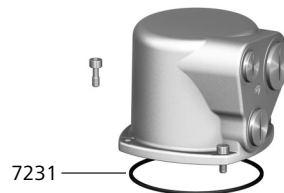

KT-M d | KT-L e

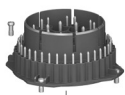
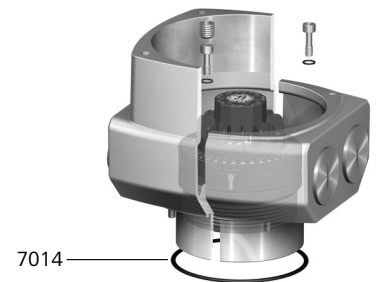
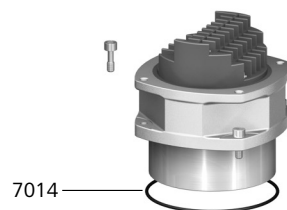
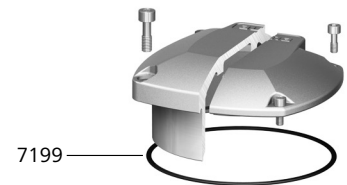

Spare parts list
auma[®]
 Multi-turn actuators
 SA(V)Ex 07.2 – SA(V)Ex 07.6
 SAR(V)Ex 07.2 – SAR(V)Ex 07.6
 Seals

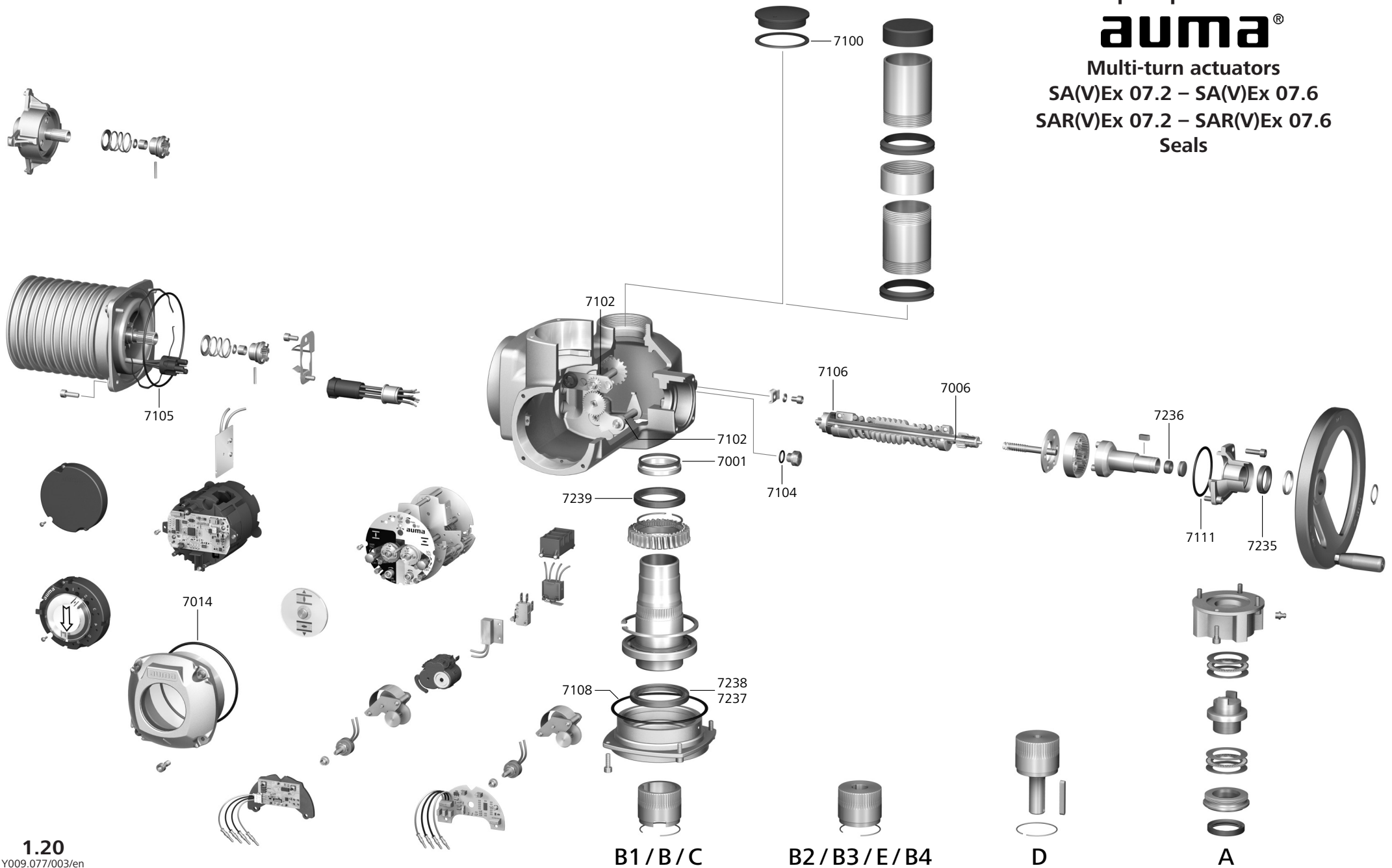

Spare parts list seals for multi-turn actuators

Seal kit small S1

This seal kit includes all seals which might be damaged or lost during commissioning, or which are needed for small maintenance.

Ref.No.	Designation / Size	Material NBR Art.-No. Z102.805	fitted Nos	Ref.No.	Designation / Size	Material FKM Art.-No. Z104.354	fitted Nos
7014	O-ring 98 x 3	D002.104	2	7014	O-ring 98 x 3	D002.572	2
7100	Rubber washer for G1¼"	Z000.107	1	7100	Rubber washer for G1¼"	Z000.107	1
7104	O-ring 12 x 2	D000.296	1	7104	O-ring 12 x 2	D002.514	1
7105	O-ring 95 x 3	D000.374	1	7105	O-ring 95 x 3	D002.140	1
7127	O-ring 135 x 3	D000.404	1	7127	O-ring 135 x 3	D002.145	1
7199	O-ring 140 x 3	D004.628	1	7199	O-ring 140 x 3	D004.628	1
7231	O-ring 100 x 3	D002.886	1	7231	O-ring 100 x 3	D003.328	1

Seal kit large S2

This seal kit includes all sealing elements installed in the actuator. Special tools are required for replacing some of them.

Ref.No.	Designation / Size	Material NBR Art.-No. Z102.806	fitted Nos	Ref.No.	Designation / Size	Material FKM Art.-No. Z104.355	fitted Nos
7001	Protector ring for hollow shaft	Z046.607	1	7001	Protector ring for hollow shaft	Z046.607	1
7006	O-ring 3,5 x 1	D003.329	1	7006	O-ring 3,5 x 1	D003.595	1
7014	O-ring 98 x 3	D002.104	2	7014	O-ring 98 x 3	D002.572	2
7100	Rubber washer for G1¼"	Z000.107	1	7100	Rubber washer for G1¼"	Z000.107	1
7102	Radial seal A10 x 19 x 7	D000.177	2	7102	Radial seal A10 x 19 x 7	D002.656	2
7104	O-ring 12 x 2	D000.296	1	7104	O-ring 12 x 2	D002.514	1
7105	O-ring 95 x 3	D000.374	1	7105	O-ring 95 x 3	D002.140	1
7106	Radial seal A12 x 28 x 7	D000.182	1	7106	Radial seal A12 x 28 x 7	D002.573	1
7108	O-ring 85 x 2,5	D000.367	1	7108	O-ring 85 x 2,5	D002.535	1
7111	O-ring 55 x 3	D000.341	1	7111	O-ring 55 x 3	D002.548	1
7127	O-ring 135 x 3	D000.404	1	7127	O-ring 135 x 3	D002.145	1
7199	O-ring 140 x 3	D004.628	1	7199	O-ring 140 x 3	D004.628	1
7231	O-ring 100 x 3	D002.886	1	7231	O-ring 100 x 3	D003.328	1
7235	Radial seal AS25 x 35 x 7	D000.206	1	7235	Radial seal AS25 x 35 x 7	D002.526	1
7236	Radial seal AS8 x 16 x 7	D003.806	1	7236	Radial seal AS8 x 16 x 7	D003.807	1
7237 ²⁾	Radial seal AS60 x 75 x 8	D003.799	1	7237 ²⁾	Radial seal AS60 x 75 x 8	D003.800	1
7238 ¹⁾	Radial seal AS45 x 60 x 7	D003.797	1	7238 ¹⁾	Radial seal AS45 x 60 x 7	D003.798	1
7239	Radial seal AS40 x 52 x 7	D003.791	1	7239	Radial seal AS40 x 52 x 7	D003.792	1

1) for F07

2) for F10