



Part-turn actuators

SQ 05.2 – SQ 14.2

SQR 05.2 – SQR 14.2

Control unit: electronic (MWG)

with actuator controls

AC 01.2 Non-Intrusive

Control

Parallel

Profibus DP

Profinet

→ Modbus RTU

Modbus TCP/IP

EtherNet/IP

Foundation Fieldbus

HART



Read operation instructions first.

- Observe safety instructions.
- These operation instructions are part of the product.
- Store operation instructions during product life.
- Pass on instructions to any subsequent user or owner of the product.

Target group:

This document contains information for assembly, commissioning and maintenance staff.

Reference documents:

- Manual (Operation and setting) of actuator controls AC 01.2 Modbus
- Manual (Fieldbus device integration) of actuator controls AC 01.2 Modbus

Reference documents are available on the Internet at: <http://www.auma.com>.

Table of contents

Page

1.	Safety instructions.....	5
1.1.	Prerequisites for the safe handling of the product	5
1.2.	Range of application	5
1.3.	Warnings and notes	6
1.4.	References and symbols	6
2.	Short description.....	7
3.	Name plate.....	9
4.	Transport and storage.....	13
4.1.	Transport	13
4.2.	Storage	14
5.	Assembly.....	16
5.1.	Mounting position	16
5.2.	Handwheel fitting	16
5.3.	Mount actuator to valve	16
5.3.1.	Overview on coupling variants	17
5.3.2.	Mount actuator (with coupling)	17
5.4.	Mounting positions of local controls	20
5.4.1.	Mounting positions: modify	20
6.	Electrical connection.....	21
6.1.	Basic information	21
6.2.	SD electrical connection (AUMA plug/socket connector)	24
6.2.1.	Terminal compartment (for mains connection): open	25
6.2.2.	Cable connection	26
6.2.3.	Terminal compartment (for mains connection): close	27
6.2.4.	Fieldbus terminal compartment: open	28
6.2.5.	Fieldbus cables: connect	29
6.2.6.	Fieldbus terminal compartment: close	30
6.3.	Accessories for electrical connection	31
6.3.1.	Actuator controls on wall bracket	31
6.3.2.	Parking frame	32
6.3.3.	DS intermediate frame for double sealing	32

6.3.4.	External earth connection	33
7.	Operation.....	34
7.1.	Manual operation	34
7.1.1.	Manual valve operation	34
7.2.	Motor operation	34
7.2.1.	Operating the actuator from local controls	34
7.2.2.	Actuator operation from remote	35
7.3.	Menu navigation via push buttons (for settings and indications)	36
7.3.1.	Menu layout and navigation	37
7.4.	User level, password	38
7.4.1.	Password entry	38
7.4.2.	Password change	39
7.4.3.	Timeout for incorrect password entry	39
7.5.	Language in the display	40
7.5.1.	Language change	40
8.	Indications.....	41
8.1.	Indications during commissioning	41
8.2.	Indications in the display	41
8.2.1.	Feedback signals from actuator and valve	42
8.2.2.	Status indications according to AUMA classification	44
8.2.3.	Status indications according to NAMUR recommendation	45
8.3.	Indication lights of local controls	47
8.4.	Mechanical position indication (self-adjusting)	47
8.5.	Mechanical position indication via indicator mark (not self-adjusting)	48
9.	Signals (output signals).....	49
9.1.	Signals via Modbus RTU	49
9.2.	Status signals via output contacts (digital outputs)	49
9.2.1.	Assignment of outputs	49
9.2.2.	Coding the outputs	49
9.3.	Analogue signals (analogue outputs)	49
10.	Commissioning (basic settings).....	51
10.1.	End stops in part-turn actuator	51
10.1.1.	Set end stop CLOSED	52
10.1.2.	Set end stop OPEN	52
10.2.	Type of seating: set	53
10.3.	Torque switching: set	54
10.4.	Limit switching: set	56
10.5.	Fieldbus address (slave address), baud rate, parity and monitoring time: set	57
10.6.	Test run	58
10.6.1.	Direction of rotation at mechanical position indicator: check	58
10.6.2.	Limit switching: check	59
11.	Commissioning (settings in the actuator).....	60
11.1.	Switch compartment: open/close	61
11.2.	Mechanical position indicator (self-adjusting)	61
11.2.1.	Mechanical position indicator: set	61
11.2.2.	Gear stage of the reduction gearing: test/set	62
11.3.	Mechanical position indication via indicator mark (not self-adjusting)	63
11.3.1.	Mechanical position indicator: set	64

11.3.2.	Gear stage of the reduction gearing: test/set	64
12.	Corrective action.....	66
12.1.	Faults during commissioning	66
12.2.	Fault indications and warning indications	66
12.3.	Fuses	70
12.3.1.	Fuses within the actuator controls	70
12.3.2.	Fuse replacement	71
12.3.2.1.	Replace fuses F1/F2	71
12.3.2.2.	Test/replace fuses F3/F4	71
12.3.3.	Motor protection (thermal monitoring)	72
13.	Servicing and maintenance.....	73
13.1.	Preventive measures for servicing and safe operation	73
13.2.	Maintenance	73
13.3.	Disposal and recycling	73
14.	Technical data.....	75
14.1.	Technical data Part-turn actuator	75
14.2.	Technical data Actuator controls	77
14.3.	Tightening torques for screws	83
15.	Spare parts.....	84
15.1.	Part-turn actuators SQ 05.2 – SQ 14.2/SQR 05.2 – SQR 14.2	84
15.2.	AC 01.2 actuator controls with SD electrical connection	86
	Index.....	88

1. Safety instructions

1.1. Prerequisites for the safe handling of the product

Standards/directives	The end user or the contractor must ensure that all legal requirements, directives, guidelines, national regulations and recommendations with respect to assembly, electrical connection, commissioning and operation are met at the place of installation. They include among others: <ul style="list-style-type: none">• Applicable configuration guidelines for fieldbus applications.
Safety instructions/warnings	All personnel working with this device must be familiar with the safety and warning instructions in this manual and observe the instructions given. Safety instructions and warning signs on the device must be observed to avoid personal injury or property damage.
Qualification of staff	Assembly, electrical connection, commissioning, operation, and maintenance must be carried out by suitably qualified personnel authorised by the end user or contractor of the plant only. Prior to working on this product, the staff must have thoroughly read and understood these instructions and, furthermore, know and observe officially recognised rules regarding occupational health and safety.
Commissioning	Prior to commissioning, imperatively check that all settings meet the requirements of the application. Incorrect settings might present a danger to the application, e.g. cause damage to the valve or the installation. The manufacturer will not be held liable for any consequential damage. Such risk lies entirely with the user.
Operation	Prerequisites for safe and smooth operation: <ul style="list-style-type: none">• Correct transport, proper storage, mounting and installation, as well as careful commissioning.• Only operate the device if it is in perfect condition while observing these instructions.• Immediately report any faults and damage and allow for corrective measures.• Observe recognised rules for occupational health and safety.• Observe national regulations.• During operation, the housing warms up and surface temperatures > 60 °C may occur. To prevent possible burns, we recommend checking the surface temperature prior to working on the device using an appropriate thermometer and wearing protective gloves.
Protective measures	The end user or the contractor are responsible for implementing required protective measures on site, such as enclosures, barriers, or personal protective equipment for the staff.
Maintenance	To ensure safe device operation, the maintenance instructions included in this manual must be observed. Any device modification requires prior written consent of the manufacturer.

1.2. Range of application

AUMA part-turn actuators SQ 05.2 – SQ 14.2/SQR 05.2 – SQR 14.2 are designed for the operation of industrial valves, e.g. butterfly valves and ball valves.

Other applications require explicit (written) confirmation by the manufacturer.

The following applications are not permitted, e.g.:

- Industrial trucks according to EN ISO 3691
- Lifting appliances according to EN 14502
- Passenger lifts according to DIN 15306 and 15309

- Service lifts according to EN 81-1/A1
- Escalators
- Continuous duty
- Buried service
- Continuous underwater use (observe enclosure protection)
- Potentially explosive areas
- Radiation exposed areas in nuclear power plants

No liability can be assumed for inappropriate or unintended use.

Observance of these operation instructions is considered as part of the device's designated use.

Information These operation instructions are only valid for the "clockwise closing" standard version, i.e. driven shaft turns clockwise to close the valve.

1.3. Warnings and notes

The following warnings draw special attention to safety-relevant procedures in these operation instructions, each marked by the appropriate signal word (DANGER, WARNING, CAUTION, NOTICE).



Indicates an imminently hazardous situation with a high level of risk. Failure to observe this warning results in death or serious injury.



Indicates a potentially hazardous situation with a medium level of risk. Failure to observe this warning could result in death or serious injury.



Indicates a potentially hazardous situation with a low level of risk. Failure to observe this warning could result in minor or moderate injury. May also be used with property damage.



Potentially hazardous situation. Failure to observe this warning could result in property damage. Is not used for personal injury.

Safety alert symbol  warns of a potential personal injury hazard.

The signal word (here: DANGER) indicates the level of hazard.

1.4. References and symbols

The following references and symbols are used in these instructions:

Information The term **Information** preceding the text indicates important notes and information.

 Symbol for CLOSED (valve closed)

 Symbol for OPEN (valve open)

M ▶ Via the menu to parameter

Describes the menu path to the parameter. When using the push buttons of local controls, the required parameter can be quickly found on the display. Display texts are shaded in grey: **Display**.

➔ Result of a process step

Describes the result of a preceding process step.

2. Short description

Part-turn actuator Definition in compliance with EN 15714-2/EN ISO 5211:

A part-turn actuator is an actuator which transmits a torque to the valve for less than one full revolution. It need not be capable of withstanding thrust.

AUMA part-turn actuator Figure 1: AUMA SQ 10.2 part-turn actuator



- [1] Part-turn actuator with motor and handwheel
- [2] Actuator controls
- [3] Local controls with display, (a) selector switch and (b) push button
- [4] Valve attachment

AUMA part-turn actuators SQ 05.2 – SQ 14.2/SQR 05.2 – SQR 14.2 are driven by an electric motor. For manual operation, a handwheel is provided. Switching off in end positions may be either by limit or torque seating. Actuator controls are required to operate or process the actuator signals.

For non-intrusive version (control unit: electromechanical version), limit and torque setting is made via switches within the actuator.

For non-intrusive version (control unit: electronic version), limit and torque setting is made via the actuator controls, neither actuator nor the actuator controls housing have to be opened. For this purpose, the actuator is equipped with an MWG (magnetic limit and torque transmitter), also capable of supplying analogue torque feedback signals/torque indication and analogue position feedback signals/position indication at the actuator controls output.

Actuator controls The actuator controls AC 01.2 may be mounted directly to the actuator or separately on a wall bracket.

The actuator can be operated via the push buttons on the local controls of the actuator controls or settings can be made in the actuator controls menu. The display shows information on the actuator as well as the menu settings.

The functions of the actuator controls include standard valve control in OPEN-CLOSE duty, positioning, process control, logging of operating data, diagnostic functions right through control via various interfaces (e.g. fieldbus, Ethernet and HART).

App and software

Using the **AUMA CDT** software for Windows-based computers (notebooks or tablets) and the **AUMA Assistant App**, actuator data can be uploaded and read, settings can be modified and stored. The connection between computer and AUMA actuator is established wireless via Bluetooth interface. With the **AUMA Cloud**, we provide an interactive platform to collect and assess e.g. detailed device data of all actuators within a plant.

Figure 2: Communication via Bluetooth

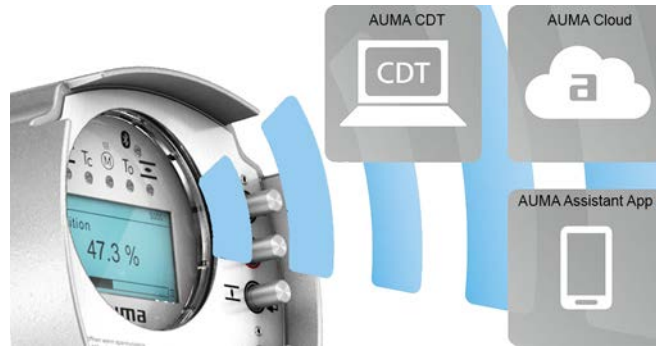

AUMA CDT

AUMA CDT is a user-friendly setting and operation program for AUMA actuators.



AUMA CDT software can be downloaded free of charge from our website www.auma.com.

AUMA Cloud

The AUMA Cloud is the driving element of the digital AUMA world, acting as interactive platform for efficient maintenance of AUMA actuators at moderate cost. The AUMA Cloud collects all device data of all actuators within one site and provides a clear overview at a glance. Detailed analysis provides valuable information on potential maintenance requirements. Additional functions foster smooth asset management.



AUMA Assistant App

The AUMA Assistant App enables remote setting and remote diagnostics of AUMA actuators via Bluetooth using either smartphone or tablet.

The AUMA Assistant App can be downloaded free of charge from the Play Store (Android) or App Store (iOS).



Figure 3: Link to AUMA Assistant App



3. Name plate

Each device component (actuator, actuator controls, motor) is equipped with a name plate.

Figure 4: Arrangement of name plates

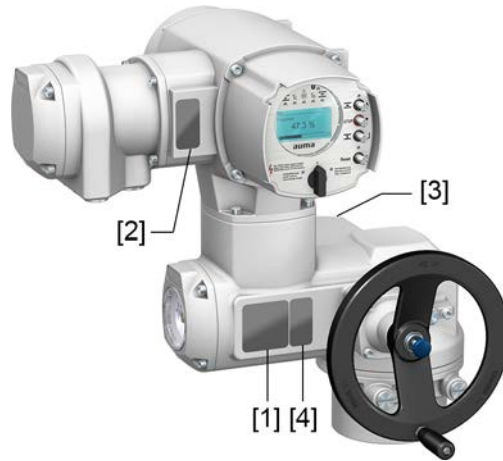

- [1] Actuator name plate
- [2] Actuator controls name plate
- [3] Motor name plate
- [4] Additional plate, e.g. KKS plate (Power Plant Classification System)

Actuator name plate

Figure 5: Actuator name plate (example)



auma (= manufacturer logo); **CE** (= CE mark)

- [1] Name of manufacturer
- [2] Address of manufacturer
- [3] **Type designation**
- [4] **Order number**
- [5] **Actuator serial number**
- [6] Operating time in [s] for a part-turn movement of 90°
- [7] Torque range in direction CLOSE
- [8] Torque range in direction OPEN
- [9] Type of lubricant
- [10] Permissible ambient temperature
- [11] Can be assigned as an option upon customer request
- [12] Enclosure protection
- [13] **Data Matrix code**

Actuator controls name plate

Figure 6: Name plate for actuator controls (example)

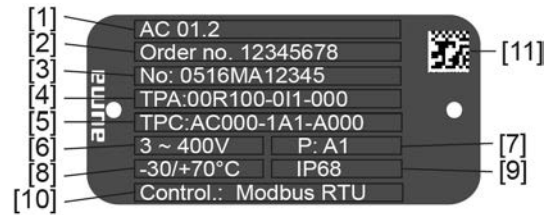

- [1] **Type designation**
- [2] **Order number**
- [3] **Serial number**
- [4] **Actuator terminal plan**
- [5] Actuator controls terminal plan
- [6] Mains voltage
- [7] **AUMA power class for switchgear**
- [8] Permissible ambient temperature
- [9] Enclosure protection
- [10] **Control**
- [11] Data Matrix code

Motor name plate

Figure 7: Motor name plate (example)



auma (= manufacturer logo); **CE** (= CE mark)

- [1] Motor type
- [2] Motor article number
- [3] Serial number
- [4] Current type, mains voltage
- [5] Rated power
- [6] Rated current
- [7] Type of duty
- [8] Enclosure protection
- [9] Motor protection (temperature protection)
- [10] Insulation class
- [11] Speed
- [12] Power factor cos phi
- [13] Mains frequency
- [14] Data Matrix code

Descriptions referring to name plate indications

Type designation

Table 1:

Description of type designation (with the example of SQ 07.2-F10)			
SQ	07.2	-F10	
SQ			Type SQ = Part-turn actuators for open-close duty Type SQR = Part-turn actuators for modulating duty
	07.2		Size These instructions apply to sizes 05.2, 07.2, 10.2, 12.2, 14.2
		F10	Flange size

Table 2:

Description of actuator controls type designation (with the example of AC 01.2)			
AC	01.2		
AC			Type AC = AUMATIC actuator controls
	01.2		Size 01.2

Order number

The product can be identified using this number and the technical data as well as order-related data pertaining to the device can be requested.

Please always state this number for any product inquiries.

On the Internet at <http://www.auma.com> > Service & Support > myAUMA, we offer a service allowing authorised users to download order-related documents such as wiring diagrams and technical data (both in German and English), inspection certificate and the operation instructions when entering the order number.

Serial number Actuator

Table 3:

Description of serial number (example of 0520NS12345)			
05	20	NS12345	
05	Positions 1+2: Assembly in week = week 05		
	20	Positions 3+4: Year of manufacture = 2020	
		NS12345	Internal number for unambiguous product identification

Actuator terminal plan

Position 9 after **TPA**: Position transmitter version

I, Q = MWG (Magnetic limit and torque transmitter)

AUMA power class for switchgear

The switchgear used in the actuator controls (reversing contactors/thyristors) are classified according to AUMA power classes (e.g. A1, B1, ...). The power class defines the max. permissible rated power (of the motor) the switchgear has been designed for. The rated power (nominal power) of the actuator motor is indicated in kW on the motor name plate. For the assignment of the AUMA power classes to the nominal power of the motor types, refer to the separate electrical data sheets.

For switchgear without assignment to any power classes, the actuator controls name plate does not indicate the power class but the max. rated power in kW.

Control

Table 4:

Control examples (indications on actuator controls name plate)	
Input signal	Description
Modbus RTU	Control via Modbus RTU interface
Modbus RTU/24 V DC	Control via Modbus RTU interface and control voltage for OPEN-CLOSE control via digital inputs (OPEN, STOP, CLOSE)

Data Matrix code

When registered as authorised user, you may use our **AUMA Assistant App** to scan the Data Matrix code and directly access the order-related product documents without having to enter order number or serial number.

Figure 8: Link to AUMA Assistant App:



For further Service & Support, Software/Apps/... refer to www.auma.com

4. Transport and storage

4.1. Transport

Actuator For transport to place of installation, use sturdy packaging.



Suspended load!

Death or serious injury.

- Do NOT stand below suspended load.
- Attach ropes or hooks for the purpose of lifting by hoist only to housing and NOT to handwheel.
- Actuators mounted on valves: Attach ropes or hooks for the purpose of lifting by hoist to valve and NOT to actuator.
- Actuators mounted to gearboxes: Attach ropes or hooks for the purpose of lifting by hoist only to the gearbox using eyebolts and NOT to the actuator.
- Actuators mounted to controls: Attach ropes or hooks for the purpose of lifting by hoist only to the actuator and NOT to the controls.
- Respect total weight of combination (actuator, actuator controls, gearbox, valve)
- Secure load against falling down, sliding or tilting.
- Perform lift trial at low height to eliminate any potential danger e.g. by tilting.

Figure 9: Example: Lifting the actuator



Weights

Table 5:

Weight for AC 01.2 actuator controls	
with electrical connection type:	Weight approx. [kg]
AUMA plug/socket connector with screw-type connection	7

Table 6:

Dimensions Part-turn actuators SQ 05.2 – SQ 14.2 / SQR 05.2 – SQR 14.2 with 3-phase AC motors		
Type designation Actuator	Weight ¹⁾ approx. [kg]	Weight with base and lever ²⁾ approx. [kg]
SQ 05.2/ SQR 05.2	21	27
SQ 07.2/ SQR 07.2	21	27
SQ 10.2/ SQR 10.2	26	31
SQ 12.2/ SQR 12.2	35	43
SQ 14.2/ SQR 14.2	44	55

- 1) Indicated weight includes AUMA NORM part-turn actuator with 3-phase AC motor, electrical connection in standard version, unbored coupling and handwheel. For other output drive types, consider additional weights.
- 2) Indicated weight includes AUMA NORM part-turn actuator with 3-phase AC motor, electrical connection in standard version, and handwheel, including base and lever. For other output drive types, consider additional weights.

Table 7:

Dimensions Part-turn actuators SQ 05.2 – SQ 14.2 / SQR 05.2 – SQR 14.2 with 1-phase AC motors		
Type designation Actuator	Weight ¹⁾ approx. [kg]	Weight with base and lever ²⁾ approx. [kg]
SQ 05.2/ SQR 05.2	23	29
SQ 07.2/ SQR 07.2	23	29
SQ 10.2/ SQR 10.2	28	32
SQ 12.2/ SQR 12.2	37	45
SQ 14.2/ SQR 14.2	46	57

- 1) Indicated weight includes AUMA NORM part-turn actuator with 1-phase AC motor, electrical connection in standard version, unbored coupling and handwheel. For other output drive types, consider additional weights.
- 2) Indicated weight includes AUMA NORM part-turn actuator with 1-phase AC motor, electrical connection in standard version, and handwheel, including base and lever. For other output drive types, consider additional weights.

4.2. Storage

NOTICE

Risk of corrosion due to inappropriate storage!

- Store in a well-ventilated, dry room.
- Protect against floor dampness by storage on a shelf or on a wooden pallet.
- Cover to protect against dust and dirt.
- Apply suitable corrosion protection agent to uncoated surfaces.

NOTICE

Risk of damage due to excessively low temperatures!

- Actuator controls may only be stored permanently down to $-30\text{ }^{\circ}\text{C}$.
 - On request, actuators controls may be transported in specific cases and for short duration at temperatures down to $-60\text{ }^{\circ}\text{C}$.
-

Long-term storage

For long-term storage (more than 6 months), observe the following points:

1. Prior to storage:
Protect uncoated surfaces, in particular the output drive parts and mounting surface, with long-term corrosion protection agent.
2. At an interval of approx. 6 months:
Check for corrosion. If first signs of corrosion show, apply new corrosion protection.

5. Assembly

5.1. Mounting position

When using grease as lubricant, the product described herein can be operated in any mounting position.

When using oil instead of grease within the actuator gear housing, perpendicular mounting position is specified whereby the flange is pointing downward. The type of lubricant used is indicated on the actuator name plate (short designation **F**...= grease; **O**...= oil).

5.2. Handwheel fitting

Figure 10: Handwheel

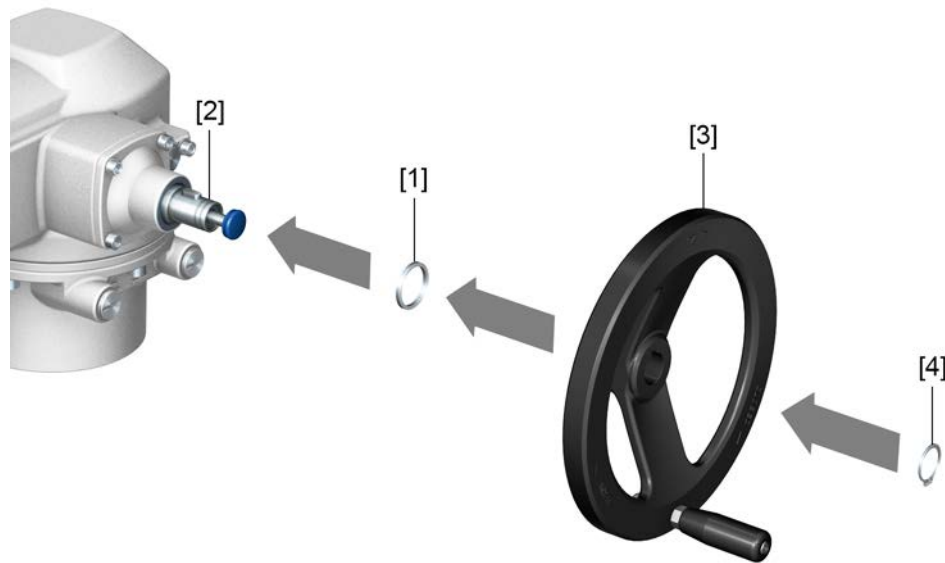

- [1] Spacer
- [2] Input shaft
- [3] Handwheel
- [4] Retaining ring

- How to proceed**
1. If required, fit spacer [1] on input shaft [2].
 2. Slip handwheel [3] onto input shaft.
 3. Secure handwheel [3] with retaining ring [4].

Information: The retaining ring [4] (together with these operation instructions) is stored in a weatherproof bag, which is attached to the device prior to delivery.

5.3. Mount actuator to valve

NOTICE

Corrosion due to damage to paint finish and condensation!

- Touch up damage to paint finish after work on the device.
- After mounting, connect the device immediately to electrical mains to ensure that heater minimises condensation.

The actuator is mounted to the valve using a coupling (standard) or via lever. Separate instructions are available for actuator mounting to the valve when equipped with base and lever.

5.3.1. Overview on coupling variants

Design Figure 11: Valve attachment via coupling

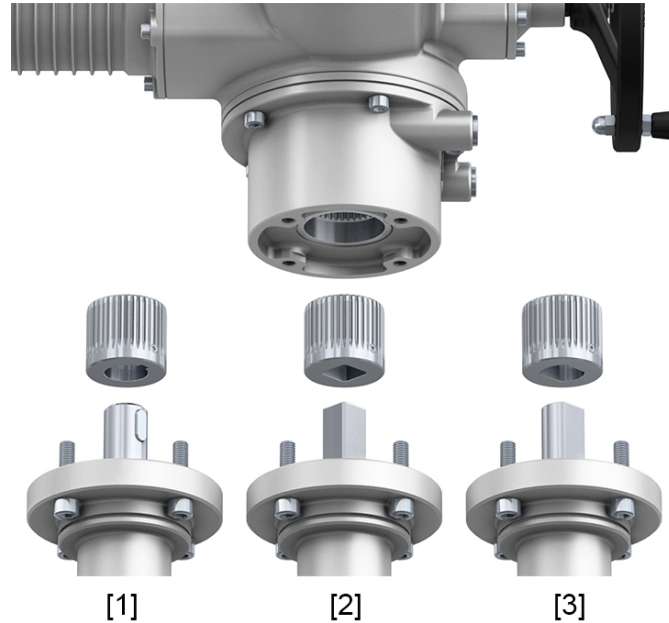

- [1] Bore with keyway
- [2] Square bore
- [3] Bore with two-flats

- Application**
- For valve attachments according to EN ISO 5211
 - For rotating, non-rising valve stem

5.3.2. Mount actuator (with coupling)

Unbored couplings or couplings with pilot bore must be machined to match the valve shaft prior to mounting the actuator to the valve (e.g. with bore and keyway, two-flat or square bore).



Assemble valve and actuator in the same end position. As standard, the actuator is supplied in end position CLOSED.

- Recommended mounting position for **butterfly valves**: End position CLOSED.
- Recommended mounting position for **ball valves**: End position OPEN.

- Assembly steps**
1. If required, move actuator in same end position as valve using the handwheel.
 2. Clean mounting faces, thoroughly degrease uncoated mounting surfaces.
 3. Apply a small quantity of grease to the valve shaft [2].

- Place coupling [1] onto valve shaft [2] and secure against axial slipping by using a grub screw [3] or a clamping washer and a screw with curved spring lock washer [4]. Thereby, ensure that dimensions X, Y or L are observed (refer to figure and table <Mounting positions for coupling>).

Figure 12: Examples: Fit coupling

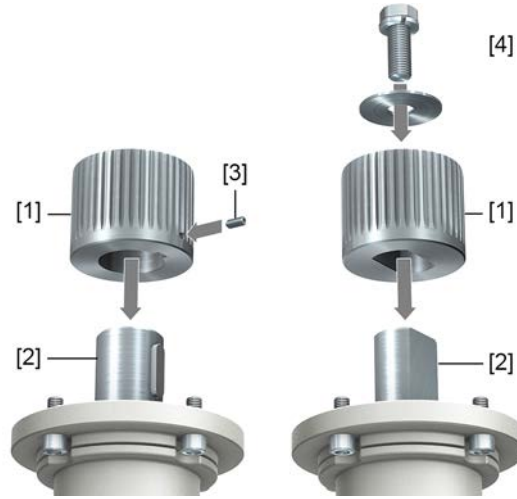

- [1] Coupling
- [2] Valve shaft
- [3] Grub screw
- [4] Clamping washer and screw with curved spring lock washer

Figure 13: Mounting positions for coupling

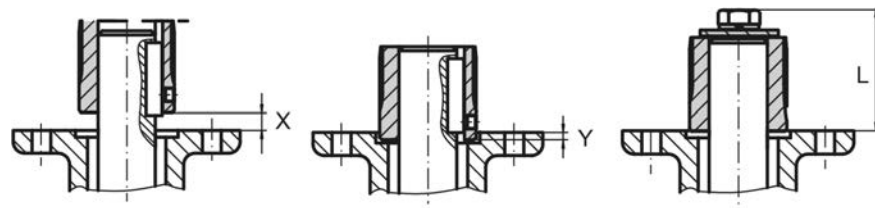
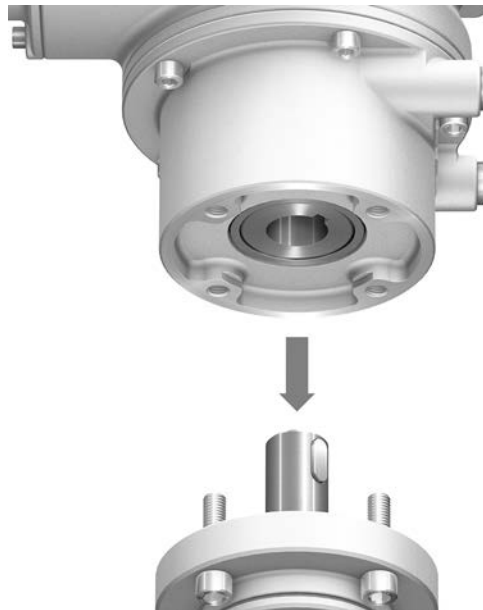

Table 8:

Mounting position of the coupling within fitting dimensions according to AUMA definition											
Dimensions [mm]	SQ 05.2		SQ 07.2			SQ 10.2		SQ 12.2		SQ 14.2	
EN ISO 5211	F05	F07	F05	F07	F10	F10	F12	F12	F14	F14	F16
X max.	3	3	3	3	3	4	4	5	5	8	8
Y max.	2	2	2	2	2	5	5	10	10	10	10
L max.	40	40	40	40	66	50	82	61	101	75	125

- Apply non-acidic grease at splines of coupling (e.g. Gleitmo by Fuchs).

6. Fit actuator. If required, slightly turn actuator until splines of coupling engage.
 Figure 14:



Information Ensure that the spigot (if provided) fits uniformly in the recess and that the flanges are in complete contact.

7. If flange bores do not match thread:
 - 7.1 Slightly rotate handwheel until bores line up.
 - 7.2 If required, shift actuator by one tooth on the coupling.
8. Fasten actuator with screws.

Information: We recommend applying liquid thread sealing material to the screws to avoid contact corrosion.

9. Fasten screws crosswise to a torque according to table.

Table 9:

Tightening torques for screws	
Threads	Tightening torque [Nm]
	Strength class A2-80/A4-80
M6	10
M8	24
M10	48
M12	82
M16	200
M20	392

5.4. Mounting positions of local controls

Figure 15: Mounting positions



The mounting position of the local controls is implemented according to the order. If, after mounting the actuator to the valve or the gearbox on site, the local controls are in an unfavourable position, the mounting position can be changed at a later date. Four mounting positions shifted by respectively 90° are possible (by maximum 180° into one direction).

5.4.1. Mounting positions: modify

DANGER

Electric shock due to presence of hazardous voltage!

Death or serious injury.

→ Disconnect device from the mains before opening.

NOTICE

Electrostatic discharge ESD!

Risk of damage to electronic components.

→ Earth both operators and devices.

1. Loosen screws and remove the local controls.
2. Check whether O-ring is in good condition, correctly insert O-ring.
3. Turn local controls into new position and re-place.

NOTICE

Cable damage due to twisting or pinching!

Risk of functional failures.

- Turn local controls by a maximum of 180°.
- Carefully assemble local controls to avoid pinching the cables.

4. Fasten screws evenly crosswise.

6. Electrical connection

6.1. Basic information



Electric shock due to presence of hazardous voltage!

Risk of death or serious injury!

- The electrical connection must be carried out exclusively by suitably qualified personnel.
- Prior to connection, observe basic information contained in this chapter.
- After connection but prior to applying the voltage, observe the <Commissioning> and <Test run> chapters.

Wiring diagram/terminal plan

The pertaining wiring diagram/terminal plan (in German or English) is attached to the device in a weather-proof bag, together with these operation instructions. It can also be requested from AUMA (state order number, refer to name plate) or downloaded directly from the Internet (<http://www.auma.com>).

Permissible networks (supply networks)

The actuators are suitable for use in TN and TT networks with directly grounded star point for nominal voltages up to maximum 690 V AC. Use in IT network is permissible for nominal voltages up to maximum 600 V AC. For IT network, a suitable, approved insulation monitor measuring the pulse code is required.

Current type, mains voltage, mains frequency

Type of current, mains voltage and mains frequency must match the data on the actuator controls and motor name plates. Also refer to chapter <Identification>/<Name plate>.

Figure 16: Motor name plate (example)

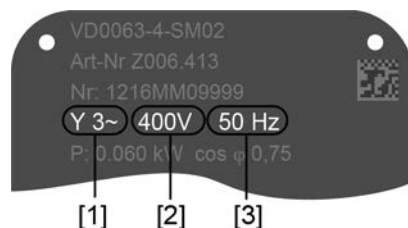

- [1] Type of current
- [2] Mains voltage
- [3] Mains frequency

External supply of the electronics

For external electronics supply, the power supply of actuator controls must have an enhanced isolation against mains voltage in compliance with IEC 61010-1 and the output power has to be limited to 150 VA in compliance with IEC 61010-1.

Protection and sizing on site

For short-circuit protection and for disconnecting the actuator from the mains, fuses and disconnect switches have to be provided by the customer.

The current values for sizing the protection can be derived from the current consumption of the motor (refer to motor name plate) plus the current consumption of actuator controls.

We recommend adapting the switchgear sizing to the max. current (I_{max}) and selecting and setting the overcurrent protection device in compliance with the indications in the electrical data sheet.

Table 10:

Current consumption of actuator controls		
Mains voltage	Max. current consumption	
Permissible variation of the mains voltage	±10 %	±30 %
100 to 120 V AC	750 mA	1,200 mA
208 to 240 V AC	400 mA	750 mA
380 to 500 V AC	250 mA	400 mA
515 to 690 V AC	200 mA	400 mA

Table 11:

Maximum permissible protection		
Switchgear (switchgear with power class) ¹⁾	Rated power	max. protection
Reversing contactor A1	up to 1.5 kW	16 A (gL/gG)
Thyristor B1	up to 1.5 kW	16 A (g/R) I _t <1,500A ² s

1) The AUMA power class (A1, B1, ...) is indicated on the actuator controls name plate

Consider the motor starting current (I_A) (refer to electrical data sheet) when selecting the circuit breaker. We recommend tripping characteristics D or K for circuit breakers in accordance with IEC 60947-2. For controls equipped with thyristors, we recommend safety fuses instead of circuit breakers. However, the use of circuit breakers is basically permitted.

We recommend refraining from using residual current devices (RCD). However, if an RCD is used within the mains, the residual current device must be of type B.

For actuator controls equipped with a heating system and external electronics power supply, the fuses for the heating system have to be provided by the customer (refer to wiring diagram F4 ext.)

Table 12:

Fuse for heating system		
Designation in wiring diagram = F4 ext.		
External power supply	115 V AC	230 V AC
Fuse	2 A T	1 A T

If actuator controls are mounted separately from actuator (actuator controls on wall bracket): Consider length and cross section of connecting cable when defining the protection required.

Potential of customer connections Safety standards

Refer to Technical data for options of isolated potentials.

Safety measures and safety equipment must comply with the respectively valid national on site specifications. All externally connected devices shall comply with the relevant safety standards applicable for the place of installation.

Connecting cables, cable glands, reducers, blanking plugs

- We recommend using connecting cables and connecting terminals according to rated current (I_N) (refer to motor name plate or electrical data sheet).
- For device insulation, appropriate (voltage-proof) cables must be used. Specify cables for the highest occurring rated voltage.
- To avoid contact corrosion, we recommend the use of sealing agents for cable glands and blanking plugs made of metal.
- Use connecting cable with appropriate minimum rated temperature.
- For connecting cables exposed to UV radiation (outdoor installation), use UV resistant cables.
- For the connection of position transmitters, screened cables must be used.

Cable installation in accordance with EMC

Signal and fieldbus cables are susceptible to interference. Motor cables are interference sources.

- Lay cables being susceptible to interference or sources of interference at the highest possible distance from each other.
- The interference immunity of signal and fieldbus cables increases if the cables are laid close to the earth potential.
- If possible, avoid laying long cables and make sure that they are installed in areas being subject to low interference.
- Avoid parallel paths with little cable distance of cables being either susceptible to interference or interference sources.

Fieldbus cable

Table 13:

Cable recommendation	
Only cables complying with the recommendations of EIA-485 specifications should be used for Modbus wiring.	
Impedance	135 to 165 Ohm, at a measurement frequency between 3 and 20 MHz
Cable capacity	< 30 pF per metre
Wire diameter	> 0.64 mm
Cross section	> 0.34 mm ² , corresponds to AWG 22
Loop resistance	< 110 Ohm per km
Screening	CU shielding braid or shielding braid and shielding foil

Prior to installation, please note:

- Connect maximum 32 devices to one segment.
- If more devices are to be connected:
 - Connect several segments using repeaters.
- Install fieldbus cables at a distance of minimum 20 cm to other cables.
- If possible, fieldbus cables should be laid in a separate, conductive, and earthed cable tray.
- Ensure absence of equipotential earth bonding differences between the individual devices at fieldbus (perform an equipotential earth bonding).

Table 14: Transmission rate/cable length for line topology

Baud rate (kbit/s)	Max. cable length (segment length) without repeater	Possible cable length with repeater (total network cable length)
9.6 – 115.2	1,200 m	Approx. 10 km

Table 15: Transmission rate/cable length for loop topology

Baud rate (kbit/s)	Max. cable length between actuators (without repeater)	Max. possible cable length of redundant loop
9.6 – 115.2	1,200 m	Approx. 290 km

6.2. SD electrical connection (AUMA plug/socket connector)

Figure 17: SD electrical connection

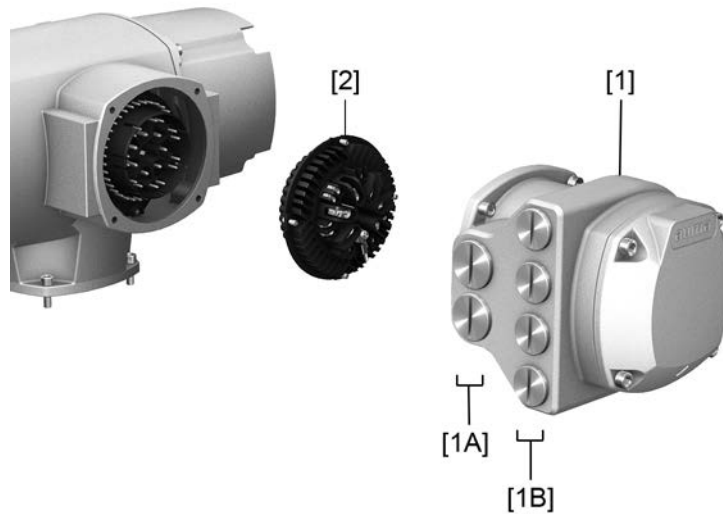

- [1] Terminal compartment (in cover)
- [1A] Cable entries for mains connection (power and control contacts)
- [1B] Cable entries for fieldbus cables
- [2] Socket carrier with screw-type terminals

Short description Plug-in electrical connection with screw-type terminals for power and control contacts. Control contacts also available as crimp-type connection as an option.

SD version. For power and control cable connection, remove the AUMA plug/socket connector and the socket carrier from terminal compartment. Removing the cover is sufficient for connecting the fieldbus cables.

Technical data

Table 16:

Electrical connection via AUMA plug/socket connector		
	Power contacts	Control contacts
No. of contacts max.	6 (3 equipped) + protective earth conductor (PE)	50 pins/sockets
Designation	U1, V1, W1, U2, V2, W2, PE	1 to 50
Connection voltage max.	750 V	250 V
Rated current max.	25 A	16 A
Type of customer connection	Screw connection	Screw connection, crimp-type (option)
Connection diameter max.	6 mm ² (flexible) 10 mm ² (solid)	2.5 mm ² (flexible or solid)

6.2.1. Terminal compartment (for mains connection): open

Figure 18: Open mains terminal compartment

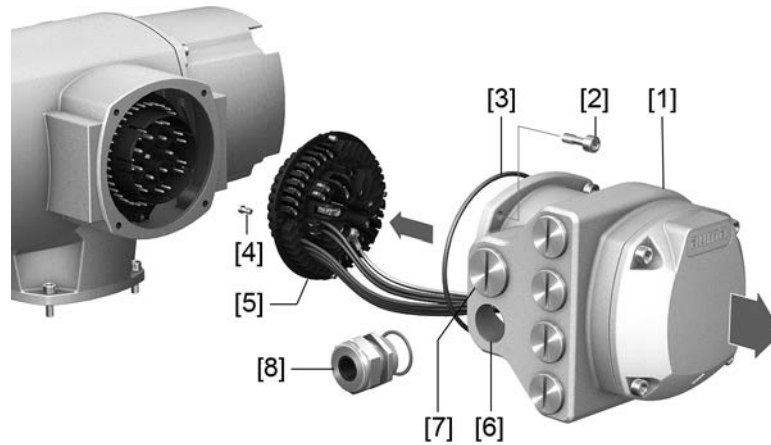

- [1] Connection housing
- [2] Screws for frame
- [3] O-ring
- [4] Screws for socket carrier
- [5] Socket carrier
- [6] Cable entries for mains connection (power and control contacts)
- [7] Blanking plug
- [8] Cable gland (not included in delivery)

Information Fieldbus operation is **not** interrupted when removing the connection housing [1].



Electric shock due to presence of hazardous voltage!

Death or serious injury.

→ Disconnect device from the mains before opening.

1. Loosen screws [2] and remove connection housing [1].
2. Loosen screws [4] and remove socket carrier [5] from connection housing [1].
3. Insert cable glands [8] suitable for connecting cables.
- ➔ The enclosure protection IP... stated on the name plate is only ensured if suitable cable glands are used.

Figure 19: Example: Name plate for enclosure protection IP68



4. Seal unused cable entries [6] with suitable blanking plugs [7].

Information Fieldbus connection can be accessed separately from the mains connection (refer to <Fieldbus terminal compartment: open>).

6.2.2. Cable connection

Table 17:

Terminal cross sections and terminal tightening torques		
Designation	Terminal cross sections	Tightening torques
Power contacts (U1, V1, W1, U2, V2, W2)	1.0 – 6 mm ² (flexible) 1.5 – 10 mm ² (solid)	1.2 – 1.5 Nm
Protective earth connection Ⓧ (PE)	1.0 – 6 mm ² (flexible) with ring lugs 1.5 – 10 mm ² (solid) with loops	1.2 – 2.2 Nm
Control contacts (1 to 50)	0.25 – 2.5 mm ² (flexible) 0.34 – 2.5 mm ² (solid)	0.5 – 0.7 Nm

1. Remove cable sheathing.
2. Insert the wires into the cable glands.
3. Fasten cable glands with the specified torque to ensure required enclosure protection.
4. Strip wires.
 - Controls approx. 6 mm, motor approx. 10 mm
5. For flexible cables: Use wire end sleeves according to DIN 46228.
6. Connect cables according to order-related wiring diagram.

⚠ WARNING

In case of a fault, electric shock due to presence of hazardous voltage if the PE conductor is NOT connected!

Risk of death or serious injury!

- Connect all protective earth conductors.
- Connect PE connection to external protective earth conductor of connecting cables.
- Start running the device only after having connected the protective earth conductor.

7. Tighten PE conductors firmly to PE connection using ring lugs (flexible cables) or loops (solid cables).

Figure 20: Protective earthing

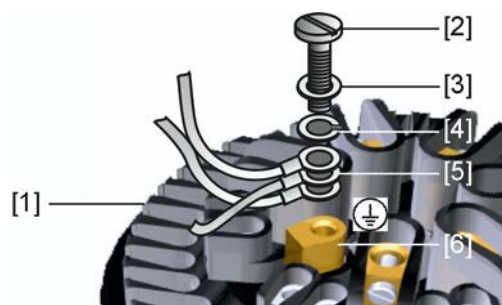

- [1] Socket carrier
- [2] Screw
- [3] Washer
- [4] Lock washer
- [5] Protective earth with ring lugs/loops
- [6] Protective earthing, symbol: Ⓧ

8. For shielded cables: Link the cable shield end via the cable gland to the housing (earthing).

6.2.3. Terminal compartment (for mains connection): close

Figure 21: Close mains terminal compartment

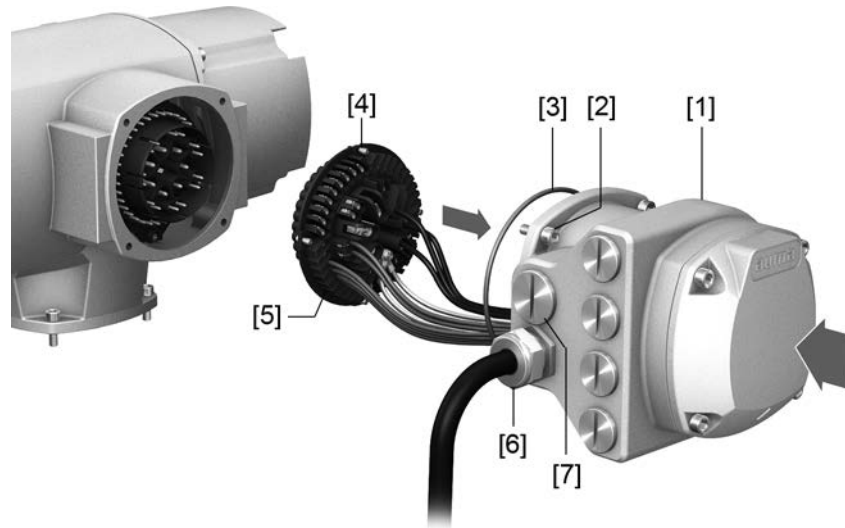

- [1] Connection housing
- [2] Screws for connection housing
- [3] O-ring
- [4] Screws for socket carrier
- [5] Socket carrier
- [6] Cable gland (not included in delivery)
- [7] Blanking plug



Short-circuit and electric shock due to pinching of cables!

Risk of death or serious injury!

→ Carefully fit socket carrier to avoid pinching the cables.

1. Insert the socket carrier [5] into the connection housing [1] and fasten with screws [4].
2. Clean sealing faces of connection housing [1] and housing.
3. Check whether O-ring [3] is in good condition, replace if damaged.
4. Apply a thin film of non-acidic grease (e.g. petroleum jelly) to the O-ring and insert it correctly.
5. Fit connection housing [1] and fasten screws [2] evenly crosswise.
6. Fasten cable glands and blanking plugs applying the specified torque to ensure the required enclosure protection.

6.2.4. Fieldbus terminal compartment: open

Figure 22: Open cover to fieldbus terminal compartment

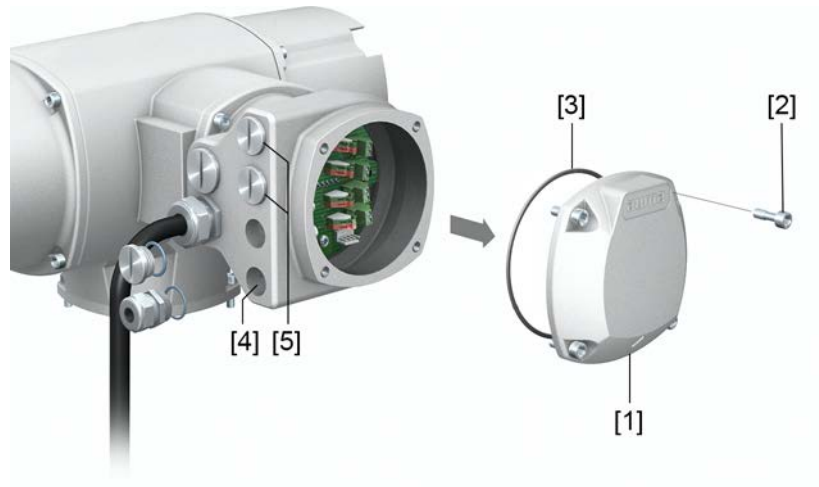

- [1] Cover (fieldbus terminal compartment)
- [2] Screws for cover
- [3] O-ring
- [4] Cable entries for fieldbus cables
- [5] Blanking plug

The AUMA plug/socket connector is equipped with a connection board for connecting the fieldbus cables. When removing the cover [1], the connection board is easily accessible.

DANGER**Electric shock due to presence of hazardous voltage!**

Death or serious injury.

→ Disconnect device from the mains before opening.

NOTICE**Electrostatic discharge ESD!**

Risk of damage to electronic components.

→ Earth both operators and devices.

1. Loosen screws [2] and remove cover [1].
2. Insert cable glands suitable for fieldbus cables.
- ➔ The enclosure protection IP... stated on the name plate is only ensured if suitable cable glands are used.

Figure 23: Example: Name plate for enclosure protection IP68



3. Seal unused cable entries with suitable plugs.

6.2.5. Fieldbus cables: connect

RS-485 connection boards

Table 18:

Variant	Overvoltage protection up to 4 kV	AUMA art. no. on label ¹⁾
1 channel (standard)	No	Z071.720/02
1 channel	Yes	Z071.720/04
2-channel for line redundancy	No	Z071.720/03
2-channel for line redundancy	Yes	Z071.720/05
2-channel for loop redundancy	No	Z102.613/01
2-channel for loop redundancy	Yes	Z102.613/02

1) Label with article number on connection board

Figure 24: Variants of connection boards

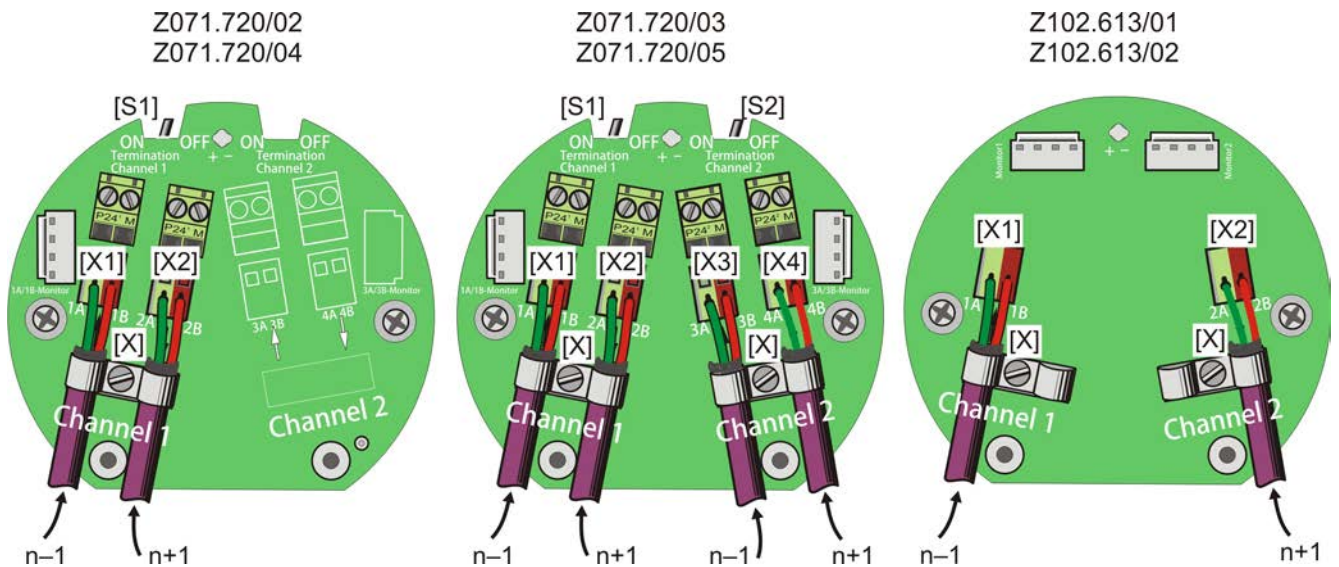

n-1 Fieldbus cable from previous device (input)

n+1 Fieldbus cable to next device (output)

[X] Shielding clamp

[X...] Terminal designation (X1, X2, X3, X4) according to wiring diagram

[S1/2] "Termination" switch for fieldbus termination

Table 19:

Functions of switches [S1] and [S2]¹⁾²⁾

[S1]	ON	Fieldbus termination channel 1 ON
	OFF	Fieldbus termination channel 1 OFF
[S2]	ON	Fieldbus termination channel 2 ON (option)
	OFF	Fieldbus termination channel 2 OFF (option)

1) Upon delivery, the switches [S1] and [S2] are set to position OFF.

2) For loop redundancy, automatic termination is performed as soon as actuator controls are connected to the power supply. When interrupting the power supply, e.g. after removing the AUMA plug/socket connector, both RS-485 loop segments are automatically connected to each other.

Cable connection

1. Always link A connections to green wire and B connections to red wire.

2. If the actuator is the final fieldbus device in the fieldbus segment:
 - 2.1 Switch on the termination resistor for channel 1 using switch [S1] (position ON).
 - 2.2 For line redundancy: Switch on the termination resistor for channel 2 using switch [S2] (position ON).

Information: As soon as the termination resistors are switched on, the connection to the next fieldbus device is automatically interrupted to avoid multiple terminations.
3. Connect cable shield largely to shielding clamp [X].

6.2.6. Fieldbus terminal compartment: close

Figure 25: Close fieldbus terminal compartment

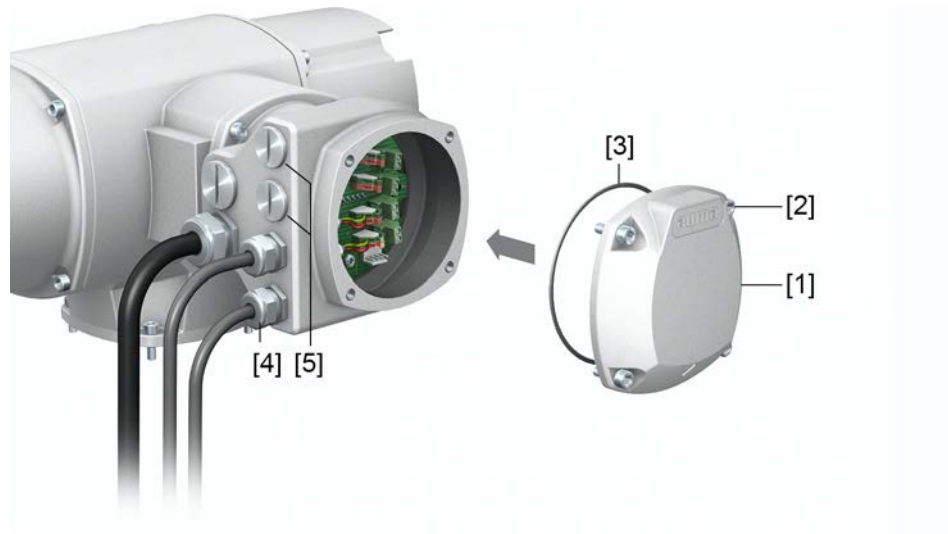

- [1] Cover (fieldbus terminal compartment)
- [2] Screws for cover
- [3] O-ring
- [4] Cable entries for fieldbus cables
- [5] Blanking plug

1. Clean sealing faces of cover [1] and housing.
2. Apply a thin film of non-acidic grease (e.g. petroleum jelly) to the sealing faces.
3. Check whether O-ring [3] is in good condition, correctly insert O-ring.
4. Fit cover [1] and fasten screws [2] evenly crosswise.
5. Fasten cable glands and blanking plugs applying the specified torque to ensure the required enclosure protection.

6.3. Accessories for electrical connection

6.3.1. Actuator controls on wall bracket

Design Figure 26: Design principle with wall bracket

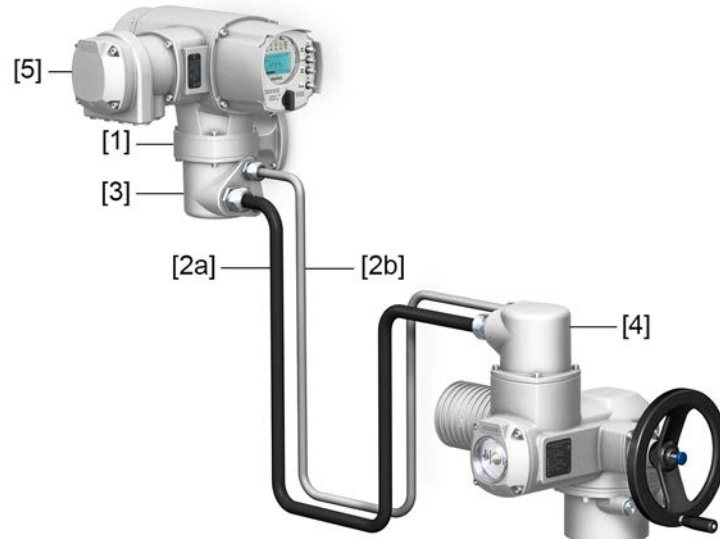

- [1] Wall bracket
- [2] Connecting cables
- [3] Electrical connection of wall bracket (XM)
- [4] Electrical connection of actuator (XA)
- [5] Elektroanschluss/Feldbusanschluss Steuerung (XK) – Kundenstecker

Application The wall bracket allows separate mounting of actuator controls and actuator.

- If the actuator cannot be accessed safely.
- If the actuator is subjected to high temperatures.
- In case of heavy vibration of the valve.

Information on installation with wall bracket

- The permissible cable length between actuator controls on wall bracket and the actuator amounts to 100 m maximum.
- We recommend using an AUMA “LSW” cable set.
- If the AUMA cable set is not used:
 - Use suitable flexible and screened connecting cables.
 - Use separate CAN bus cable of 120 Ohm character impedance for MWG (e.g. UNITRONIC BUS-FD P CAN UL/CSA - 2 x 2 x 0.5 mm², manufacturer: Lapp).
 - Data cable connection: XM2-XA2 = CAN L, XM3-XA3 = CAN H.
 - Voltage supply MWG: XM6-XA6 = GND, XM7-XA7 = + 24 V DC (refer to wiring diagram).
- For the electrical connection at wall bracket [3], the terminals are made as crimp connections.
 - Use a suitable four indent crimp tool for crimping.
 - Cross sections for flexible wires:
 - Control cables: max. 0.75 to 1.5 mm²
 - Mains connection: max. 2.5 to 4 mm²

- When using connecting cables, e.g. of the heater or switch, requiring direct wiring from the actuator to the XK customer plug (XA-XM-XK, refer to wiring diagram), these connecting cables must be subject to an insulation test in compliance with EN 50178. Connecting cables of position transmitters (EWG, RWG, IWG, potentiometer) do not belong to this group. They may **not** be subjected to an insulation test.

6.3.2. Parking frame

Figure 27: Parking frame, example with AUMA plug/socket connector and cover



Application Parking frame for safe storage of a disconnected plug or cover.

For protection against touching the bare contacts and against environmental influences.

6.3.3. DS intermediate frame for double sealing

Figure 28: Electrical connection with DS intermediate frame

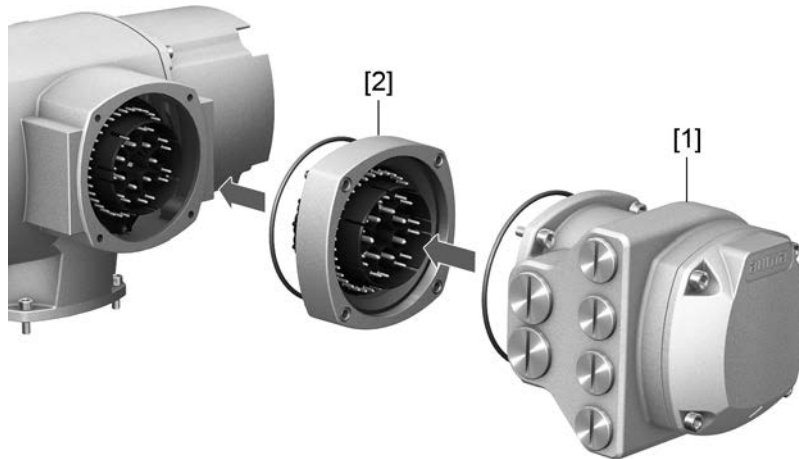

[1] Electrical connection

[2] DS intermediate frame

Application When removing the electrical connection or due to leaky cable glands, there is a potential risk of ingress of dust and water into the housing. This is prevented effectively by inserting the double sealed intermediate frame [2] between the plug/socket connector [1] and the housing of the device. The enclosure protection of the device (IP68) will not be affected, even if the electrical connection [1] is removed.

6.3.4. External earth connection

Figure 29: Earth connection for part-turn actuator



Application External earth connection (U-bracket) for connection to equipotential compensation.

Table 20:

Terminal cross sections and earth connection tightening torques		
Conductor type	Terminal cross sections	Tightening torques
Solid wire and stranded	2.5 mm ² to 6 mm ²	3 – 4 Nm
Fine stranded	1.5 mm ² to 4 mm ²	3 – 4 Nm

For fine stranded (flexible) wires, connection is made via cable lugs/ring terminals. When connecting two individual wires with a U-bracket, cross sections have to be identical.

7. Operation

7.1. Manual operation

For purposes of setting and commissioning, in case of motor or power failure, the actuator may be operated manually. Manual operation is engaged by an internal change-over mechanism.

Manual operation is automatically disengaged when motor is started again. The handwheel does not rotate during motor operation.

7.1.1. Manual valve operation



Damage at the manual change-over mechanism/motor coupling due to faulty operation!

- Engage manual operation only during motor standstill.
- Do NOT use extensions as lever for operation.

1. Press push button.
2. Turn handwheel in desired direction.



↳ The closing direction is marked on the handwheel.

Table 21: Handwheel marking (examples)

→ For valve closing, turn handwheel in direction of the arrowhead.	
 Clockwise closing	 Counterclockwise closing
Drive shaft (valve) turns clockwise in direction CLOSE.	Drive shaft (valve) turns counterclockwise in direction CLOSE.

7.2. Motor operation



Valve damage due to incorrect basic setting!

- Prior to electric actuator operation, perform the basic settings for “type of seating” and “torque switching”.

7.2.1. Operating the actuator from local controls

Local actuator operation is performed using the local controls push buttons of actuator controls.

Figure 30: Local controls



- [1] Push button for operation command in direction OPEN
- [2] Push button STOP
- [3] Push button for operation command in direction CLOSE
- [4] Push button RESET
- [5] Selector switch

CAUTION

Hot surfaces, e.g. possibly caused by high ambient temperatures or strong direct sunlight!

Risk of burns

→ Verify surface temperature and wear protective gloves.

→ Set selector switch [5] to position **Local control** (LOCAL).

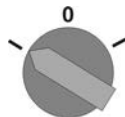

➔ The actuator can now be operated using the push buttons [1 – 3]:

- Run actuator in direction OPEN: Press push button [1]
- Stop actuator: Press push button STOP [2].
- Run actuator in direction CLOSE: Press push button [3]

Information

The OPEN and CLOSE operation commands can be given either in push-to-run or in self-retaining operation mode. In self-retaining mode, the actuator runs to the defined end position after pressing the button, unless another command has been received beforehand. For further information, please refer to the Manual (Operation and setting).

7.2.2. Actuator operation from remote

CAUTION

Risk of immediate actuator operation when switching on!

Risk of personal injuries or damage to the valve

- If the actuator starts unexpectedly: Immediately turn selector switch to **0** (OFF).
- Check input signals and functions.

→ Set selector switch to position **Remote control** (REMOTE).

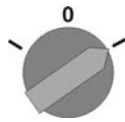

➔ Now, the actuator can be remote-controlled via fieldbus.

Information For actuators equipped with a positioner, it is possible to change over between **OPEN - CLOSE control** (Remote OPEN-CLOSE) and **setpoint control** (Remote SET-POINT). For further information, please refer to the Manual (Operation and setting).

7.3. Menu navigation via push buttons (for settings and indications)

Menu navigation for display and setting is made via the push buttons [1 – 4] of the local controls.

Set the selector switch [5] to position **0** (OFF) when navigating through the menu.

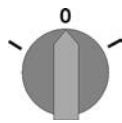

The bottom row of the display [6] serves as navigation support and explains which push buttons [1 – 4] are used for menu navigation.

Figure 31:

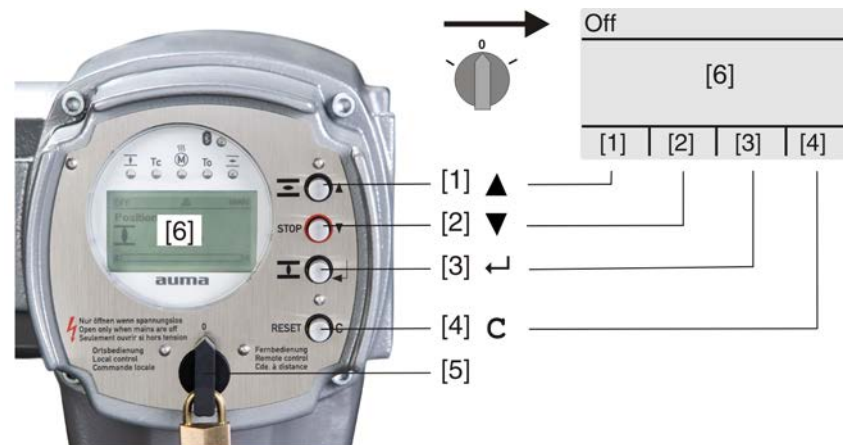

[1–4] Push buttons or navigation support

[5] Selector switch

[6] Display

Table 22: Important push button functions for menu navigation

Push buttons	Navigation support on display	Functions
[1] ▲	Up ▲	Change screen/selection Change values Enter figures from 0 to 9
[2] ▼	Down ▼	Change screen/selection Change values Enter figures from 0 to 9
[3] ↵	Ok	Confirm selection
	Save	Save
	Edit	Enter <Edit> menu
	Details	Display more details

Push buttons	Navigation support on display	Functions
[4] C	Setup	Enter Main menu
	Esc	Cancel process
		Return to previous display

- Backlight**
- The display is illuminated in white during normal operation. It is illuminated in red in case of a fault.
 - The screen illumination is brighter when operating a push button. If no push button is operated for 60 seconds, the display will become dim again.

7.3.1. Menu layout and navigation

Groups The indications on the display are divided into 3 groups:

Figure 32: Groups

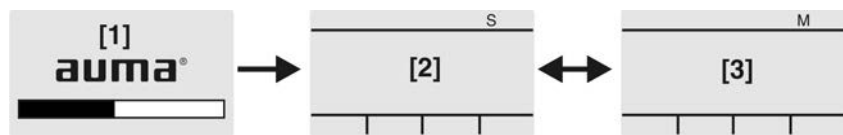

- [1] Start menu
- [2] Status menu
- [3] Main menu

ID Status menu and main menu are marked with an ID.

Figure 33: Marking with ID

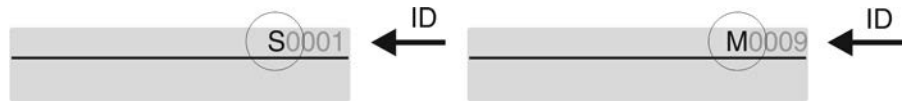

- S ID starts with S = status menu
- M ID starts with M = main menu

Group selection It is possible to select between status menu **S** and main menu **M**:

For this, set selector switch to **0** (OFF), hold down push button **C** for approx. 2 seconds until a screen containing the ID **M...** appears.

Figure 34: Select menu groups

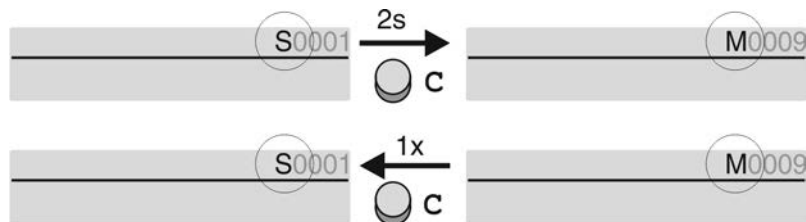

You return to the status menu if:

- the push buttons on the local controls have not been operated within 10 minutes
- or by briefly pressing **C**

Direct display via ID When entering the ID within the main menu, screens can be displayed directly (without clicking through).

Figure 35: Direct display (example)

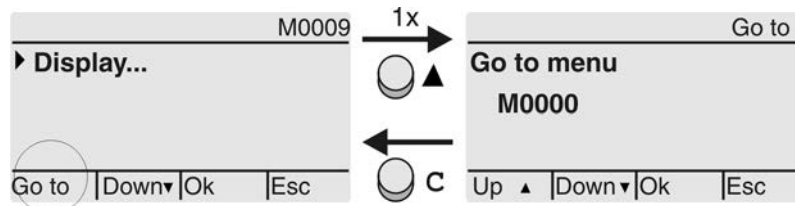

Display indicates in the bottom row: **Go to**

1. Press push button **▲ Go to**.
Display indicates: **Go to menu M0000**
2. Use push buttons **▲▼ Up ▲ Down ▼** to select figures 0 to 9.
3. Press push button **↵ Ok** to confirm first digit.
4. Repeat steps 2 and 3 for all further digits.
5. To cancel the process: Press **C Esc**.

7.4. User level, password

User level The user level defines which menu items or parameters can be displayed or modified by the active user.

There are 6 different user levels. The user level is indicated in the top row:

Figure 36: User level display (example)

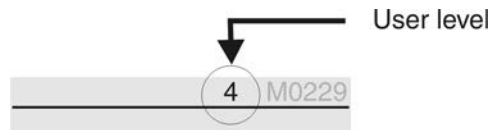

Password A password must be entered to allow parameter modification. The display indicates: **Password 0*****

A specific password is assigned to each user level and permits different actions.

Table 23:

User levels and authorisations	
Designation (user level)	Authorisation/password
Observer (1)	Verify settings No password required
Operator (2)	Change settings Default factory password: 0000
Maintenance (3)	Reserved for future extensions
Specialist (4)	Change device configuration e.g. type of seating, assignment of output contacts Default factory password: 0000
Service (5)	Service staff Change configuration settings
AUMA (6)	AUMA administrator



Unauthorised access is made easier due to insecure password!

→ We urgently recommend changing the password during initial commissioning.

7.4.1. Password entry

1. Select desired menu and hold down push button **↵** for approx. 3 seconds.
➡ Display indicates the set user level, e.g **Observer (1)**
2. Select higher user level via **▲ Up ▲** and confirm with **↵ Ok**.
➡ Display indicates: **Password 0*****

3. Use push buttons ▲▼ Up ▲ Down ▼ to select figures 0 to 9.
 4. Confirm first digit of password via push button ◀ Ok.
 5. Repeat steps 1 and 2 for all further digits.
- ➔ Having confirmed the last digit with ◀ Ok, access to all parameters within one user level is possible if the password entry is correct.

7.4.2. Password change

Only the passwords of same or lower access level may be changed.

Example: If the user is signed in as Specialist (4), he/she can change passwords as for password levels (1) through (4).

M ▶ **Device configuration M0053**
Service functions M0222
Change passwords M0229

Menu item **Service functions M0222** is only visible, if user level **Specialist (4)** or higher is selected.

Select main menu

1. Set selector switch to position **0** (OFF).

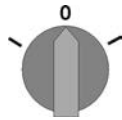

Change passwords

2. Press push button **C Setup** and hold it down for approx. 3 seconds.

➔ Display goes to main menu and indicates: ▶ **Display**

3. Select parameter **Change passwords** either:
 - click via the menu M ▶ to parameter, or
 - via direct display: press ▲ and enter ID **M0229**
- Display indicates: ▶ **Change passwords**
- The user level is indicated in the top row (1 – 6), e.g.:



4. For a user level between 2 and 6: Press push button ◀ Ok.
- ➔ The display indicates the highest user level, e.g.: **For user 4**
5. Select user level via push buttons ▲▼ Up ▲ Down ▼ and confirm with ◀ Ok.
- ➔ Display indicates: ▶ **Change passwords Password 0*****
6. Enter current password (→ enter password).
- ➔ Display indicates: ▶ **Change passwords Password (new) 0*****
7. Enter new password (→ enter password).
- ➔ Display indicates: ▶ **Change passwords For user 4** (example)
8. Select next user level via push buttons ▲▼ Up ▲ Down ▼ or cancel the process via Esc.

7.4.3. Timeout for incorrect password entry

A timeout for incorrect password entry is provided with actuator controls. This prevents unauthorised access by systematic trials. The timeout is active for incorrect entries via the local controls as well as incorrect entries via our software tools (AUMA CDT, AUMA Assistant App). After five subsequent incorrect trials, further entry is inhibited for one minute. Each further incorrect entry doubles the timeout period. An active

timeout is displayed on the screen. An individual timeout is available for each user level. This means that you may still log on with user level 3 if user level 4 is inhibited.

The incorrect entry counter can be reset in two ways:

1. Correct password entry with successful access authorisation.
2. 8 hours after the last incorrect entry.

7.5. Language in the display

The display language can be selected.

7.5.1. Language change

M ▶ **Display** M0009
Language M0049

Select main menu

1. Set selector switch to position **0** (OFF).

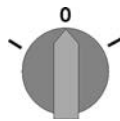

Change language

2. Press push button **C Setup** and hold it down for approx. 3 seconds.
 - ➔ Display goes to main menu and indicates: ▶ **Display**
3. Press **← Ok**.
 - ➔ Display indicates: ▶ **Language**
4. Press **← Ok**.
 - ➔ Display indicates the selected language, e.g.: ▶ **Deutsch**
5. The bottom row of the display indicates:
 - **Save** → continue with step 10
 - **Edit** → continue with step 6
6. Press **← Edit**.
 - ➔ Display indicates: ▶ **Observer (1)**
7. Select user level via **▲▼ Up ▲ Down ▼** resulting in the following significations:
 - black triangle: ▶ = current setting
 - white triangle: ▷ = selection (not saved yet)
8. Press **← Ok**.
 - ➔ Display indicates: **Password 0*****
9. Enter password (→ enter password).
 - ➔ Display indicates: ▶ **Language** and **Save** (bottom row)

Language selection

10. Select new language via **▲▼ Up ▲ Down ▼** resulting in the following significations:
 - black triangle: ▶ = current setting
 - white triangle: ▷ = selection (not saved yet)
11. Confirm selection via **← Save**.
 - ➔ The display changes to the new language. The new language selection is saved.

8. Indications

8.1. Indications during commissioning

LED test When switching on the power supply, all LEDs on the local controls illuminate for approx. 1 second. This optical feedback indicates that the voltage supply is connected to the controls and all LEDs are operable.

Figure 37: LED test

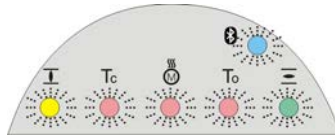

Language selection During the self-test, the language selection can be activated so that the selected language is immediately indicated in the display. For this, set selector switch to position **0** (OFF).

Activate language selection:

1. Display indicates in the bottom line: **Language selection menu? 'Reset'**
2. Hold down push button **RESET** until display of the following text in the bottom line: **Language menu loading, please wait.**

Figure 38: Self-test

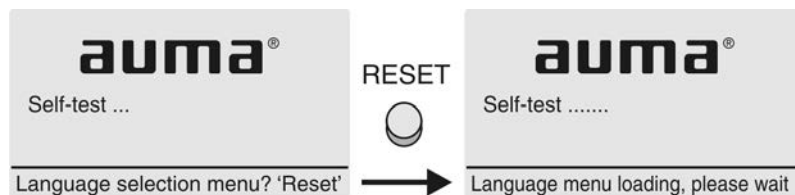

The language selection menu follows the startup menu.

Startup menu The current firmware version is displayed during the startup procedure:

Figure 39: Startup menu with firmware version: 05.00.00–xxxx

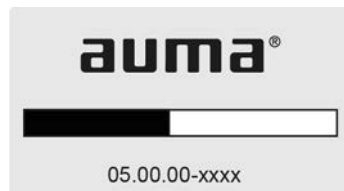

If the language selection feature has been activated during the self-test, the menu for selecting the display language will now be indicated. For further information on language setting, please refer to chapter <Language in the display>.

Figure 40: Language selection

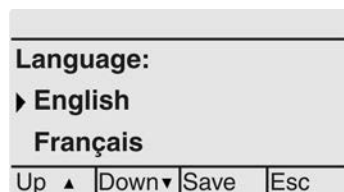

If no entry is made over a longer period of time (approx. 1 minute), the display automatically returns to the first status indication.

8.2. Indications in the display



Menus and functions depend on the actuator controls firmware version!

→ Should menus or functions be unavailable, please contact the AUMA Service.

Status bar The status bar (first row in the display) indicates the operation mode [1], the presence of an error [2] and the ID number [3] of the current display indication.

Figure 41: Information in the status bar (top)

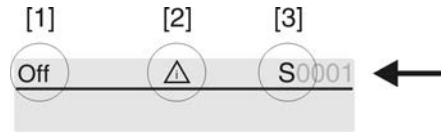

- [1] Operation mode
- [2] Error symbol (only for faults and warnings)
- [3] ID number: S = Status page

Navigation support If further details or information are available with reference to the display, the following indications **Details** or **More** appear in the navigation support (bottom display row). Then, further information can be displayed via the ← push button.

Figure 42: Navigation support (bottom)

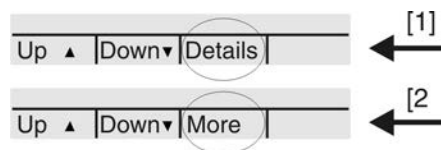

- [1] shows list with detailed indications
- [2] shows further available information

The navigation support (bottom row) is faded out after approx. 3 seconds. Press any push button (selector switch in position 0 (OFF)) to fade in the navigation support.

8.2.1. Feedback signals from actuator and valve

Display indications depend on the actuator version.

Valve position (S0001)

- S0001 on the display indicates the valve position in % of the travel.
- The bar graph display appears after approx. 3 seconds.
- When issuing an operation command, an arrow indicates the direction (OPEN/CLOSE).

Figure 43: Valve position and direction of operation

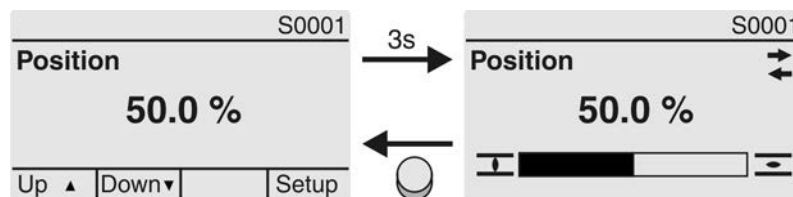



Reaching the preset end positions is additionally indicated via  (CLOSED) and  (OPEN) symbols.

Figure 44: End position CLOSED/OPEN reached



- 0% Actuator is in end position CLOSED
- 100% Actuator is in end position OPEN

Torque (S0002)

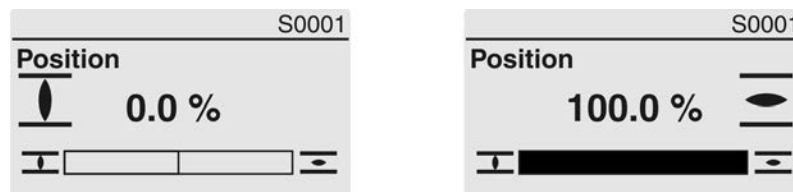
- S0002 on the display indicates the torque applied at the actuator output.

- The bar graph display appears after approx. 3 seconds.

Figure 45: Torque

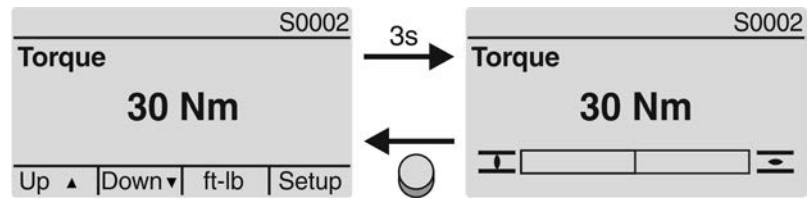

Select unit

The push button allows to select the unit displayed (percent %, Newton metre Nm or "foot-pound" ft-lb)

Figure 46: Units of torque

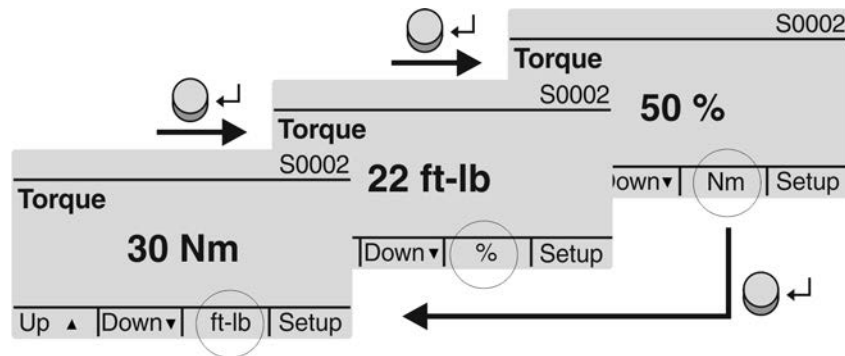

Display in percent

100 % indication equals the max. torque indicated on the name plate of the actuator.

Example: Torque range on name plate = 20 – 60 Nm.

- 100 % corresponds to 60 Nm of nominal torque.
- 50 % corresponds to 30 Nm of nominal torque.

Operation commands (S0003)

The display S0003 indicates:

- active operation commands, like e.g.: Operation in direction CLOSE or in direction OPEN
- the actual value E2 as bar graph indication and as value between 0 and 100 %.
- for setpoint control (positioner): setpoint E1
- for stepping mode or for intermediate positions with operation profile: pivot points and operation behaviour of pivot points

The navigation support (bottom row) is faded out after approx. 3 seconds and the axis/axes for pivot point display are shown.

OPEN - CLOSE control

Active operation commands (OPEN, CLOSE, ...) are shown above the bar graph display. The figure below shows the operation command in direction CLOSE.

Figure 47: Display for OPEN - CLOSE control

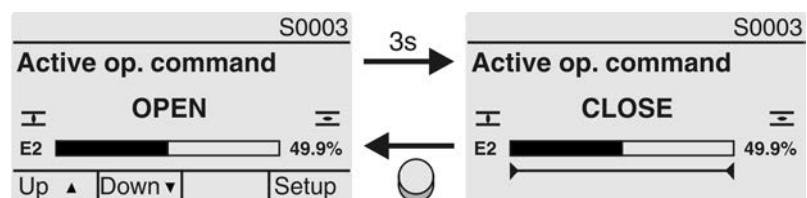

E2 Actual position value

Setpoint control

If the positioner is enabled and activated, the bar graph indication for E1 (position setpoint) is displayed.

The direction of the operation command is displayed by an arrow above the bar graph indication. The figure below shows the operation command in direction CLOSE.

Figure 48: Indication for setpoint control (positioner)

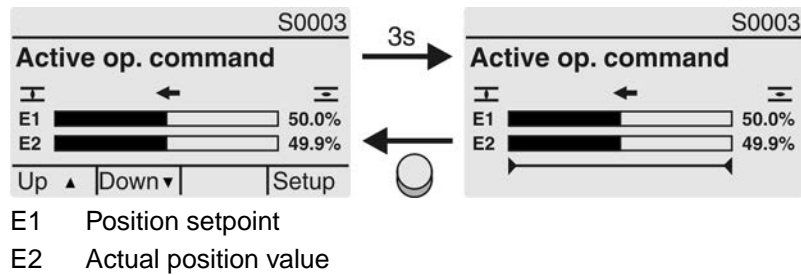

Pivot point axis

The pivot points and their operation behaviour (operation profile) are shown on the pivot point axis by means of symbols.

The symbols are only displayed if at least one of the following functions is activated:

Operation profile M0294

Timer CLOSE M0156

Timer OPEN M0206

Figure 49: Examples: on the left pivot points (intermediate positions); on the right stepping mode



Table 24: Symbols along the pivot point axis

Symbol	Pivot point (intermediate position) with operation profile	Stepping mode
	Pivot point without reaction	End of stepping mode
◀	Stop during operation in direction CLOSE	Start of stepping mode in direction CLOSE
▶	Stop during operation in direction OPEN	Start of stepping mode in direction OPEN
◆	Stop during operation in directions OPEN and CLOSE	–
◁	Pause for operation in direction CLOSE	–
▷	Pause for operation in direction OPEN	–
◇	Pause for operation in directions OPEN and CLOSE	–

8.2.2. Status indications according to AUMA classification

These indications are available if the parameter **Diagnostic classific. M0539** is set to **AUMA**.

Warnings (S0005)

If a warning has occurred, the display shows **S0005**:

- the number of warnings occurred
- a blinking question mark after approx. 3 seconds

Figure 50: Warnings

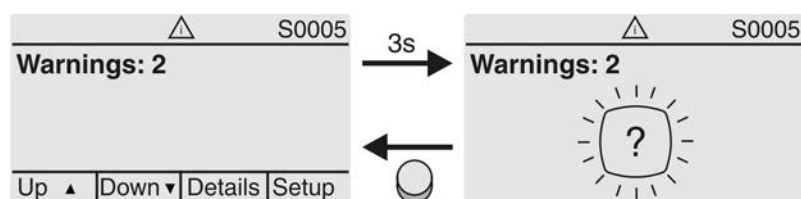

For further information, please also refer to <Corrective action>.

Not ready REMOTE (S0006)

The S0006 display shows indications of the Not ready REMOTE group.

If such an indication has occurred, the display shows S0006:

- the number of indications occurred
- a blinking crossbar after approx. 3 seconds

Figure 51: Not ready REMOTE indications

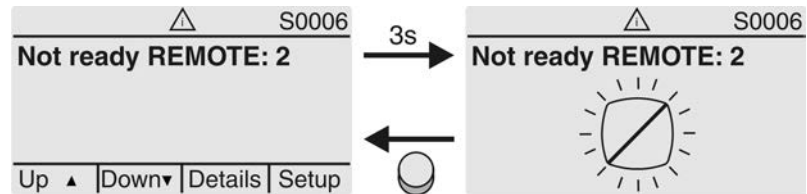

For further information, please also refer to <Corrective action>.

Fault (S0007)

Once a fault has occurred, the S0007 display shows:

- the number of faults occurred
- a blinking exclamation mark after approx. 3 seconds

Figure 52: Fault

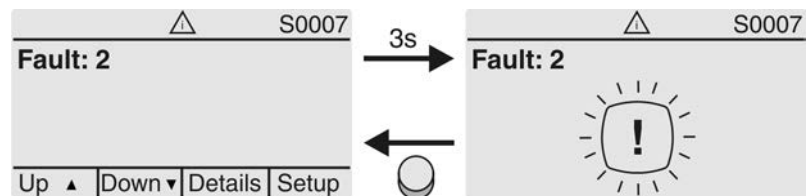

For further information, please also refer to <Corrective action>.

8.2.3. Status indications according to NAMUR recommendation

These indications are available, if the parameter **Diagnostic classific. M0539** is set to **NAMUR**.

Out of Specification (S0008)

The S0008 indication shows out of specification indications according to NAMUR recommendation NE 107.

If such an indication has occurred, the display shows S0008:

- the number of indications occurred
- a blinking triangle with question mark after approx. 3 seconds

Figure 53: Out of specification

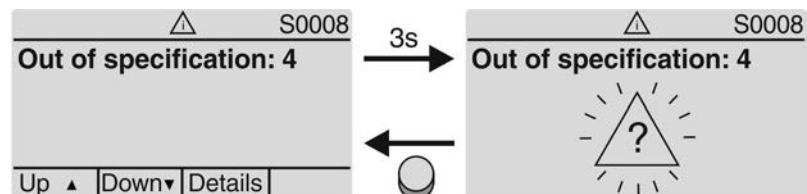

For further information, please also refer to <Corrective action>.

Function check (S0009)

The S0009 indication shows function check indications according to NAMUR recommendation NE 107.

If an indication has occurred via the function check, the display shows S0009:

- the number of indications occurred
- a blinking triangle with a spanner after approx. 3 seconds

Figure 54: Function check

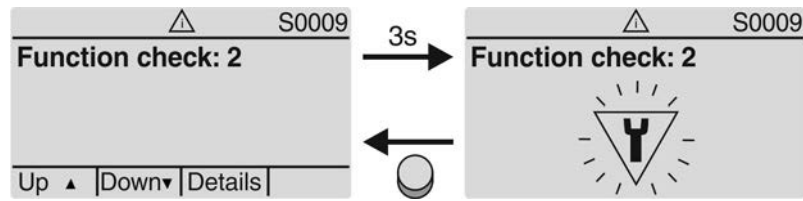

For further information, please also refer to <Corrective action>.

Maintenance required (S0010)

The S0010 indication shows maintenance indications according to NAMUR recommendation NE 107.

If such an indication has occurred, the display shows S0010:

- the number of indications occurred
- a blinking square with an oilcan after approx. 3 seconds

Figure 55: Maintenance required

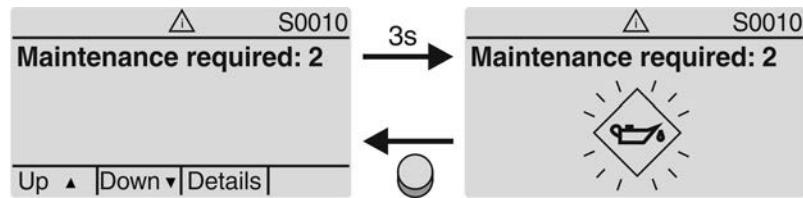

For further information, please also refer to <Corrective action>.

Failure (S0011)

The S0011 indication shows the causes of the failure indication according to NAMUR recommendation NE 107.

If such an indication has occurred, the display shows S0011:

- the number of indications occurred
- a blinking circle with a cross after approx. 3 seconds

Figure 56: Failure

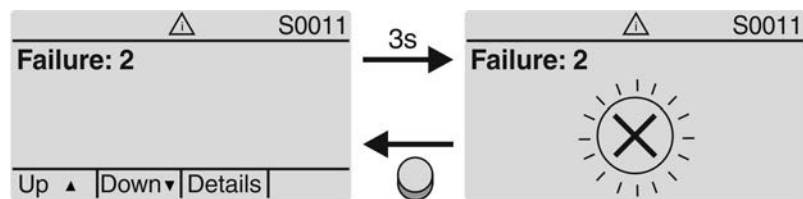

For further information, please also refer to <Corrective action>.

8.3. Indication lights of local controls

Figure 57: Arrangement and signification of indication lights



- [1] Marking with symbols (standard)
- [2] Marking with figures 1 – 6 (option)
- 1 End position CLOSED reached (blinking: operation in direction CLOSE)
- 2 Tc Torque fault CLOSE
- 3 Motor protection tripped
- 4 To Torque fault OPEN
- 5 End position OPEN reached (blinking: operation in direction OPEN)
- 6 Bluetooth connection active

Modify indication light assignment (indications)

Different indications can be assigned to LEDs 1 – 5.

- M ▷ **Device configuration M0053**
- Local controls M0159**
- Indication light 1 (left) M0093**
- Indication light 2 M0094**
- Indication light 3 M0095**
- Indication light 4 M0096**
- Indicat. light 5 (right) M0097**
- Signal interm. pos. M0167**

Default values (Europe):

- Indication light 1 (left) = End p. CLOSED, blink
- Indication light 2 = Torque fault CLOSE
- Indication light 3 = Thermal fault
- Indication light 4 = Torque fault OPEN
- Indicat. light 5 (right) = End p. OPEN, blink
- Signal interm. pos. = OPEN/CLOSED = Off

Further setting values:

Refer to Manual (Operation and setting).

8.4. Mechanical position indication (self-adjusting)

Figure 58: Mechanical position indicator



- [1] End position OPEN reached
- [2] End position CLOSED reached

- Characteristics**
- Independent of power supply
 - Used as running indication: Indicator disc (with arrow \Rightarrow) rotates during actuator operation and continuously indicates the valve position
(For “clockwise closing version”, the arrow rotates in clockwise direction for operation in direction CLOSE)
 - Indicates that end positions (OPEN/CLOSED) have been reached
Arrow \Rightarrow points to symbol $\overline{\text{O}}$ (OPEN) or $\overline{\text{I}}$ (CLOSED)
 - Self-adjusting when increasing the swing angle

8.5. Mechanical position indication via indicator mark (not self-adjusting)

Figure 59: Mechanical position indicator



- [1] End position OPEN reached
[2] End position CLOSED reached
[3] Indicator mark at cover

- Characteristics**
- Independent of power supply
 - Used as running indication: Indicator disc rotates during actuator operation and continuously indicates the valve position
(For “clockwise closing ” version, the symbols $\overline{\text{O}}$ / $\overline{\text{I}}$ rotate in counterclockwise direction for operations in direction CLOSE)
 - Indicates that end positions (OPEN/CLOSED) have been reached
(Symbols $\overline{\text{O}}$ (OPEN)/ $\overline{\text{I}}$ (CLOSED) point to the indicator mark \blacktriangle at cover)

9. Signals (output signals)

9.1. Signals via Modbus RTU

The feedback signals via Modbus RTU can be read using the appropriate Modbus function codes.

For further information, please refer to the Manual (Device integration fieldbus) Modbus.

9.2. Status signals via output contacts (digital outputs)

- Conditions** Output contacts are only available if a parallel interface is provided in addition to the fieldbus interface.
- Characteristics** Output contacts are used to send status signals (e.g. reaching the end positions, selector switch position, faults...) as binary signals to the control room.
- Status signals only have two states: active or inactive. Active means that the conditions for the signal are fulfilled.

9.2.1. Assignment of outputs

The output contacts (outputs DOUT 1 – 6) can be assigned to various signals.

Required user level: **Specialist (4)** or higher.

M ▶ **Device configuration M0053**
I/O interface M0139
Digital outputs M0110
Signal DOUT 1 M0109

Default values:

Signal DOUT 1 = Fault
Signal DOUT 2 = End position CLOSED
Signal DOUT 3 = End position OPEN
Signal DOUT 4 = Selector sw. REMOTE
Signal DOUT 5 = Torque fault CLOSE
Signal DOUT 6 = Torque fault OPEN

9.2.2. Coding the outputs

The output signals **Coding DOUT 1 – Coding DOUT 6** can be set either to high active or low active.

- High active = output contact closed = signal active
- Low active = output contact open = signal active

Signal active means that the conditions for the signal are fulfilled.

Required user level: **Specialist (4)** or higher.

M ▶ **Device configuration M0053**
I/O interface M0139
Digital outputs M0110
Coding DOUT 1 M0102

Default values:

Coding DOUT 1 = Low active
Coding DOUT 2–Coding DOUT 6 = High active

9.3. Analogue signals (analogue outputs)

- Requirements** Analogue signals are only available if additional input signals are provided.
- Valve position** Signal: E2 = 0/4 – 20 mA (galvanically isolated)
Designation in the wiring diagram: AOUT1 (position)
- Torque feedback** Signal: E6 = 0/4 – 20 mA (galvanically isolated)

Designation in the wiring diagram: AOUT2 (torque)

For further information on this topic, please refer to Manual (Operation and setting).

10. Commissioning (basic settings)

1. Set selector switch to position **0** (OFF).

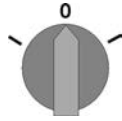

Information: The selector switch is not a mains switch. When positioned to **0** (OFF), the actuator cannot be operated. The controls' power supply is maintained.

2. Switch on the power supply.

Information: Observe heat-up time for ambient temperatures below $-30\text{ }^{\circ}\text{C}$.

3. Perform basic settings.

10.1. End stops in part-turn actuator



The following description applies for clockwise closing standard version.

Separate instructions are available for counterclockwise special version.

The internal end stops limit the swing angle. They protect the valve in case of limit switching failure during motor operation and serve the purpose as limitation for manual operation via handwheel. They may not be used for torque tripping in end positions during standard operation.

End stop setting is generally performed by the valve manufacturer **prior** to installing the valve into the pipework.

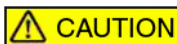

Exposed, rotating parts (discs/balls) at the valve!

Pinching and damage by valve or actuator.

- End stops should be set by suitably qualified personnel only.
- Never completely remove the setting screws [2] and [4] to avoid grease leakage.
- Observe dimension T_{\min} .

Information

- The swing angle set in the factory is indicated on the name plate:
Figure 60: Example: Swing angle on name plate



- The setting sequence depends on the valve:
 - Recommendation for **butterfly valves**: Set end stop CLOSED first.
 - Recommendation for **ball valves**: Set end stop OPEN first.

Figure 61: End stop

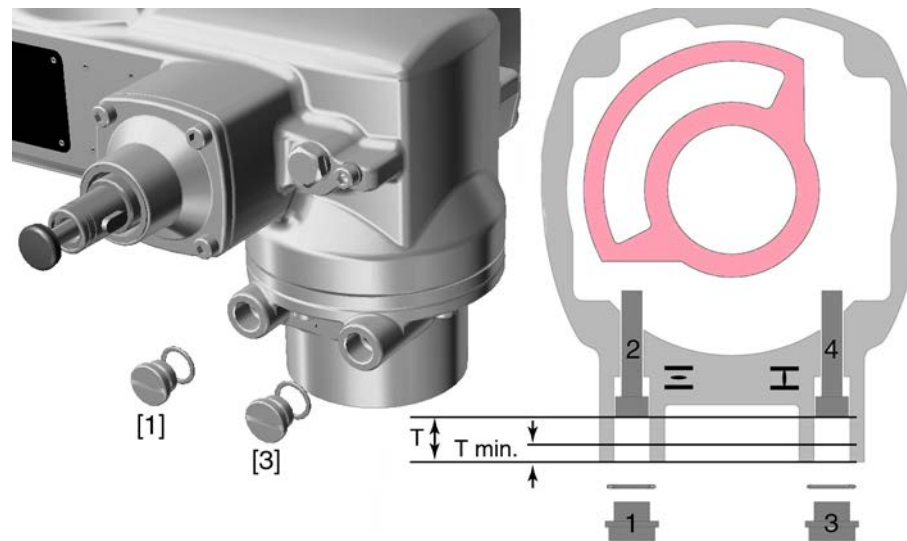

- [1] Screw plug for end stop OPEN
- [2] Setting screw for end stop OPEN
- [3] Screw plug for end stop CLOSED
- [4] Setting screw for end stop CLOSED

Dimensions/sizes	05.2	07.2	10.2	12.2	14.2
T (for 90°)	17	17	20	23	23
T _{min.}	11	11	12	13	12

10.1.1. Set end stop CLOSED

1. Remove screw plug [3].
2. Move valve to end position CLOSED with handwheel.
3. If the valve end position is not reached:
 - Slightly turn setting screw [4] counterclockwise until valve end position CLOSED can be safely set.
 - ➔ Turning the setting screw [4] clockwise results in a smaller swing angle.
 - ➔ Turning the setting screw [4] counterclockwise results in a larger swing angle.



4. Turn setting screw [4] clockwise to the stop.
 - ➔ This completes the setting of end stop CLOSED.
5. Check O-ring of screw plug for seat and condition, replace if damaged.
6. Fasten and tighten screw plug [1].

Having completed this procedure, the end position detection CLOSED can be set immediately.

10.1.2. Set end stop OPEN

Information In general, the end stop OPEN does not have to be set.

1. Remove screw plug [1].
2. Move valve to end position OPEN with handwheel.

3. If the valve end position is not reached:
 - Slightly turn setting screw [2] counterclockwise until valve end position OPEN can be safely set.
 - ➔ Turning the setting screw [2] clockwise results in a smaller swing angle.
 - ➔ Turning the setting screw [2] counterclockwise results in a larger swing angle.



4. Turn setting screw [2] clockwise to the stop.
 - ➔ This completes the setting of end stop OPEN.
 5. Check O-ring of screw plug for seat and condition, replace if damaged.
 6. Fasten and tighten screw plug [1].
- Having completed this procedure, the end position detection OPEN can be set immediately.

10.2. Type of seating: set

NOTICE

Valve damage due to incorrect setting!

- The type of seating setting (limit or torque seating) must match the selection for the valve.
- Only change the setting with prior consent of the valve manufacturer.

- M ▷** Customer settings M0041
 Type of seating M0012
 End position CLOSED M0086
 End position OPEN M0087

Default value: Limit

Setting values:

- Limit** Seating in end positions via limit switching.
- Torque** Seating in end positions via torque switching.

- Select main menu** 1. Set selector switch to position **0** (OFF).

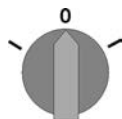

2. Press push button **C Setup** and hold it down for approx. 3 seconds.
 - ➔ Display goes to main menu and indicates: ▶ **Display**

- Select parameter** 3. Select parameter either:
- click via the menu **M ▷** to parameter, or
 - via direct display: Press **▲** and enter ID **M0086** or **M0087**
- ➔ Display indicates: **End position CLOSED**

- CLOSE or OPEN** 4. Use **▲ ▼ Up ▲ Down ▼** to select:
- ▶ **End position CLOSED**
 - ▶ **End position OPEN**
- ➔ The black triangle ▶ indicates the current selection.

5. Press **← Ok**.
- ➔ Display indicates the current setting: **Limit** or **Torque**
 - ➔ The bottom row of the display indicates either:
 - **Edit** → continue with step 6
 - **Save** → continue with step 10
6. Press **← Edit**.
- ➔ Display indicates: ▶ **Specialist (4)**
- User login** 7. Use **▲▼ Up ▲ Down ▼** to select user:
- Information:** Required user level: **Specialist (4)** or higher
- ➔ The symbols have the following meaning:
 - black triangle: ▶ = current setting
 - white triangle: ▷ = selection (not saved yet)
8. Press **← Ok**.
- ➔ Display indicates: **Password 0*****
9. Enter password (→ enter password).
- ➔ The screen indicates the pre-set type of seating (▶**Limit** or ▶**Torque**) by means of a black triangle ▶.
- Change settings** 10. Use **▲▼ Up ▲ Down ▼** to select new setting.
- ➔ The symbols have the following meaning:
 - black triangle: ▶ = current setting
 - white triangle: ▷ = selection (not saved yet)
11. Confirm selection via **← Save**.
- ➔ The setting for the type of seating is complete.
12. Back to step 4 (CLOSED or OPEN): Press **← Esc**.

10.3. Torque switching: set

Once the set torque is reached, the torque switches will be tripped (overload protection of the valve).

Information The torque switches may also trip during manual operation.

NOTICE

Valve damage due to excessive tripping torque limit setting!

- The tripping torque must suit the valve.
- Only change the setting with the consent of the valve manufacturer.

M ▶ **Customer settings M0041**
Torque switching M0013
Trip torque CLOSE M0088
Trip torque OPEN M0089

Default value: According to order data

Setting range: Torque range according to actuator name plate

- Select main menu** 1. Set selector switch to position **0** (OFF).

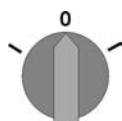

2. Press push button **C Setup** and hold it down for approx. 3 seconds.
- ➔ Display goes to main menu and indicates: ▶ **Display**

- Select parameter** 3. Select parameter either:
- click via the menu **M ▶** to parameter, or
 - via direct display: press **▲** and enter ID **M0088**.
- Display indicates: **Trip torque CLOSE**
- CLOSE or OPEN** 4. Use **▲▼ Up ▲ Down ▼** to select:
- **▶ Trip torque CLOSE**
 - **▶ Trip torque OPEN**
- The black triangle **▶** indicates the current selection.
5. **↵** Press **Ok**.
- Display shows the set value.
- The bottom row indicates: **Edit Esc**
6. **↵** Press **Edit**.
- Display indicates:
- **Specialist (4)** → continue with step 7
 - in bottom row **Up ▲ Down ▼ Esc** → continue with step 11
- User login** 7. Use **▲▼ Up ▲ Down ▼** to select user:
- Information:** Required user level: **Specialist (4)** or higher.
- The symbols have the following meanings:
- black triangle: **▶** = current setting
 - white triangle: **▷** = selection (not saved yet)
8. **↵** Press **Ok**.
- Display indicates: **Password 0*****
9. Enter password (→ enter password).
- Display shows the set value.
- The bottom row indicates: **Edit Esc**
10. **↵** Press **Edit**.
- Change value** 11. Enter new value for tripping torque via **▲▼ Up ▲ Down ▼**.
- Information:** The adjustable torque range is shown in round brackets.
12. Save new value via **↵ Save**.
- The tripping torque is set.
13. Back to step 4 (CLOSED or OPEN): Press **↵ Esc**.
- Information** The following fault signals are issued if the torque setting performed has been reached **in mid-travel**:
- In the display of the local controls: Status indication **S0007 Fault = Torque fault OPEN** or **Torque fault CLOSE**
- The fault has to be acknowledged before the operation can be resumed. The acknowledgement is made:
1. either by an operation command in the opposite direction.
 - For **Torque fault OPEN**: Operation command in direction **CLOSE**
 - For **Torque fault CLOSE**: Operation command in direction **OPEN**
 2. or, in case the torque applied is lower than the preset tripping torque:
 - in selector switch position **Local control (LOCAL)** via push button **RESET**.
 - in selector switch position **Remote control (REMOTE)**:
 - via the fieldbus, command **reset.**, if the fieldbus is the active command source.
 - via a digital input (I/O interface) with **RESET** command if a digital input is configured for signal **RESET** and the I/O interface is the active command source.

10.4. Limit switching: set**NOTICE****Valve damage at valve/gearbox due to incorrect setting!**

- When setting with motor operation: Stop actuator **prior** to reaching end of travel (press STOP push button).
- For limit seating, provide for sufficient backlash between end position and mechanical end stop due to potential overrun.

M ▶ Customer settings M0041
 Limit switching M0010
 Set end pos. CLOSED? M0084
 Set end pos. OPEN? M0085

Select main menu

1. Set selector switch to position **0** (OFF).

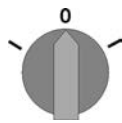

2. Press push button **C** and hold it down for approx. 3 seconds.

➔ Display goes to main menu and indicates: ▶ **Display**

Select parameter

3. Select parameter either:

- click via the menu **M ▶** to parameter, or
- via direct display: press **▲** and enter ID **M0084**.

➔ Display indicates: **Set end pos. CLOSED?**

CLOSED or OPEN

4. Select via **▲ ▼ Up ▲ Down ▼**:

- ▶ **Set end pos. CLOSED? M0084**
- ▶ **Set end pos. OPEN? M0085**

➔ The black triangle ▶ indicates the current selection.

5. Press **◀ Ok**.

➔ The display indicates either:

- **Set end pos. CLOSED? CMD0009** → continue with step 9
- **Set end pos. OPEN? CMD0010** → continue with step 12
- **Specialist (4)** → continue with step 6

User login

6. Use **▲ ▼ Up ▲ Down ▼** to select user:

Information: Required user level: **Specialist (4)** or higher

➔ The symbols have the following meaning:

- black triangle: ▶ = current setting
- white triangle: ▷ = selection (not saved yet)



7. Press **Ok** to confirm selected user.

➔ Display indicates: **Password 0*****

8. Enter password (→ enter password).

➔ The display indicates either:

- **Set end pos. CLOSED? CMD0009** → continue with step 9
- **Set end pos. OPEN? CMD0010** → continue with step 12

- Set end position CLOSED** **CMD0009**
9. Set end position CLOSED again :
 - 9.1 For large strokes: Set selector switch in position **Local control** (LOCAL) and operate actuator in motor operation via push button  (CLOSE) in direction of the end position.
Information: Stop actuator **before** reaching end of travel (press **STOP** push button to avoid damage).
 - 9.2 Engage manual operation.
 - 9.3 Turn handwheel until valve is closed.
 - 9.4 Set selector switch to position **0** (OFF).
 ➔ Display indicates: **Set end pos.CLOSED? Yes No**
- Confirm new end position**
10. Press **← Yes** to confirm new end position.
 ➔ Display indicates: **End pos. CLOSED set!**
 ➔ The left LED is illuminated (standard version) and thus indicates that the end position CLOSED setting is complete.
-
11. Make selection:
 - **Edit** → back to step 9: Set end position CLOSED "once again"
 - **Esc** → back to step 4; either set end position OPEN or exit the menu.
- Set end position OPEN** **CMD0010**
12. Re-set end position OPEN:
 - 12.1 For large strokes: Set selector switch in position **Local control** (LOCAL) and operate actuator in motor operation via push button  (OPEN) in direction of the end position.
Information: Stop actuator **before** reaching end of travel (press **STOP** push button to avoid damage).
 - 12.2 Engage manual operation.
 - 12.3 Turn handwheel until valve is open.
 - 12.4 Set selector switch to position **0** (OFF).
 ➔ Display indicates: **Set end pos. OPEN? Yes No**
- Confirm new end position**
13. Press **← Yes** to confirm new end position.
 ➔ Display indicates: **End pos. OPEN set!**
 ➔ The right LED is illuminated (standard version) and thus indicates that the end position OPEN setting is complete.
-
14. Make selection:
 - **Edit** → back to step 12: Set end position OPEN "once again"
 - **Esc** → back to step 4; either set end position CLOSED or exit the menu.
- Information** If an end position cannot be set: Check the type of control unit in actuator.

10.5. Fieldbus address (slave address), baud rate, parity and monitoring time: set

- M▷ **Customer settings** M0041
- Modbus** M0341
- MD1 slave address** M0247

MD2 slave address M0409
Baud rate M0343
Parity/stop bit M0782
Monitoring time M0781

Default values:

MD1 slave address = 247
MD2 slave address = 247
Baud rate = Auto
Parity/stop bit = Even, 1 stop bit
Monitoring time = 15 seconds

Information Parameter MD2 slave address is only available if AUMA redundancy I (option) is available.

For further settings and information e.g. on redundancy, refer to Manual (Device integration).

10.6. Test run

Only perform test run only once all settings previously described have been performed.

10.6.1. Direction of rotation at mechanical position indicator: check

NOTICE**Valve damage due to incorrect direction of rotation!**

- If the direction of rotation is wrong, switch off immediately (press STOP).
- Eliminate cause, i.e. correct phase sequence for cable set wall bracket.
- Repeat test run.

Information Switch off before reaching the end position.

1. Move actuator manually to intermediate position or to sufficient distance from end position.

2. Switch on actuator in direction CLOSE and observe the direction of rotation on the mechanical position indication:

→ **For self-adjusting mechanical position indication:**

- ➔ The direction of rotation is correct if the actuator operates in direction **CLOSE** and arrow \Rightarrow turns **clockwise** in direction CLOSE (symbol $\overline{\text{I}}$).

Figure 62: Direction of rotation \Rightarrow (for “clockwise closing” version”)



→ **For mechanical position indication via indicator mark: (not self-adjusting)**

- ➔ The direction of rotation is correct if the actuator operation in direction **CLOSE** and the symbols $\overline{\text{I}}$ turn **counterclockwise**:

Figure 63: Direction of rotation $\overline{\text{I}}$ (for “clockwise closing version”)



10.6.2. Limit switching: check

1. Set selector switch to position **Local control** (LOCAL).

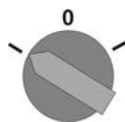

2. Operate actuator using push buttons OPEN, STOP, CLOSE.

➔ The limit switching is set correctly if (default indication):

- the yellow indication light/LED1 is illuminated in end position CLOSED
- the green indication light/LED5 is illuminated in end position OPEN
- the indication lights go out after travelling into opposite direction.

➔ The limit switching is set incorrectly if:

- the actuator comes to a standstill before reaching the end position
- one of the red indication lights/LEDs is illuminated (torque fault)
- the status indication **S0007** in the display signals a fault.

3. If the end position setting is incorrect: Reset limit switching.

11. Commissioning (settings in the actuator)

Figure 64: Mechanical position indicator (self-adjusting)



The actuator is supplied with the swing angle set in the factory in compliance with the order. The mechanical position indication is set to this swing angle.

If the factory swing angle is changed at a later date, the position indicator must be adapted to the new swing angle:

- Increasing the swing angle: The mechanical position indication automatically adjusts with the subsequent operation.
- Decreasing the swing angle: The mechanical position indication must be newly set (refer to the subsequent chapters).

Figure 65: Mechanical position indication via indicator mark (not self-adjusting)



In case the mechanical position indication integrated within the actuator is NOT self-adjusting, the switch compartment must be opened for mechanical position indication adjustment when commissioning.

11.1. Switch compartment: open/close

Figure 66: Open/close switch compartment

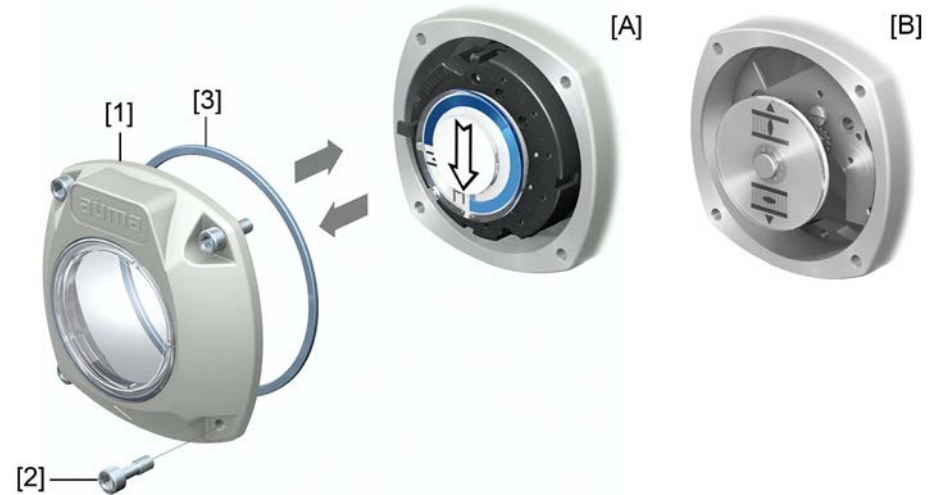

- [A] Mechanical position indication (self-adjusting)
- [B] Mechanical position indication via indicator mark

- | | |
|--------------|---|
| Open | 1. Loosen screws [2] and remove cover [1] from the switch compartment. |
| Close | 2. Clean sealing faces of housing and cover. |
| | 3. Check whether O-ring [3] is in good condition, replace if damaged. |
| | 4. Apply a thin film of non-acidic grease (e.g. petroleum jelly) to the O-ring and insert it correctly. |
| | 5. Place cover [1] on switch compartment. |
| | 6. Fasten screws [2] evenly crosswise. |

11.2. Mechanical position indicator (self-adjusting)

Figure 67: Mechanical position indicator (self-adjusting)



The self-adjusting mechanical position indicator shows the valve position by means of an arrow \Rightarrow . When correctly set, the arrow points to symbol \equiv (OPEN) or \equiv (CLOSED) in the end positions.

Information The position indications is housed in the actuator switch compartment. Opening the switch compartment for manual setting is only necessary if the gear stage setting must be modified or if the factory settings of predefined end position CLOSED (or OPEN) must be adapted when commissioning.

11.2.1. Mechanical position indicator: set

1. Move valve to end position CLOSED.



2. Push both lower discs with the symbols  (OPEN) and  (CLOSED) towards each other. The disc with the arrow is thereby  is driven:

Figure 68: Setting position in CLOSED





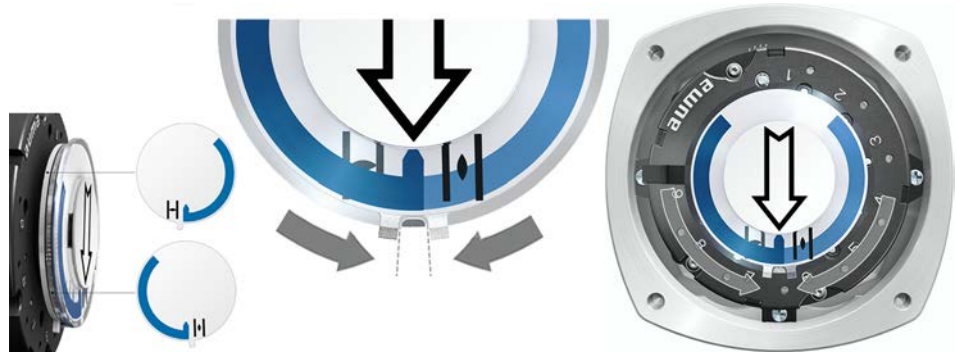

3. Move actuator to end position OPEN.
 - The arrow  rotates in direction OPEN driving the indicator disc with symbol  (OPEN) until the actuator stops in position OPEN.

Figure 69: Operation in direction OPEN (left) and position OPEN (right)



4. Check settings:
 - The setting of the mechanical position indicator is correct if the angle between the symbols  (OPEN) and  (CLOSED) ranges between approx. 120° and 280°.
 - If all three discs are turned at the same time, the indicator can be shifted in steps of 15°. Individual shifts of 5° are possible.
 - If the indicator is rotated too far (more than 280°) or if the angle is too small (below 120°), adapt the gear stage setting to the actuator swing angle. Refer to <Gear stage of the reduction gearing: test/set>.

11.2.2. Gear stage of the reduction gearing: test/set

The test/setting is only required if the mechanical position indicator cannot be correctly set or if another swing angle range is ordered subsequently, for example, 120° ±15° instead of 90° ±15° (replacement by the AUMA Service only).

1. Refer to table and check if swing angle corresponds to the setting of the reduction gearing (stages 1– 9).

Table 25:

Actuator swing angle and suitable reduction gearing setting				
	SQ 05.2 / SQ 07.2	SQ 10.2	SQ 12.2	SQ 14.2
30° +/-15°	2	2	3	4
60° +/-15°	3	3	4	5
90° +/-15°	3	3	4	6
120° +/-15°	3	4	5	6
150° +/-15°	4	4	5	6
180° +/-15°	4	4	5	7
210° +/-15°	4	5	6	7
290° +/-70°	5	5	6	7

2. To modify settings, lift the lever at the reduction gearing and engage at the selected stage.



Figure 70: Set reduction gearing



11.3. Mechanical position indication via indicator mark (not self-adjusting)

Figure 71: Mechanical position indication via indicator mark



The mechanical position indicator shows the valve position via two indicator discs with symbols  (OPEN) and  (CLOSED). When correctly set, the symbols OPEN/CLOSED point to the indicator mark  at the cover in the end positions.

Setting elements

The position indications is housed in the actuator switch compartment. The switch compartment must be opened to perform any settings. Refer to <Switch compartment: open/close>.

11.3.1. Mechanical position indicator: set

✓ If options (e.g. potentiometer, position transmitter) are available: Only set mechanical position indication once all optional equipment have been successfully set.

1. Move valve to end position CLOSED.
2. Turn lower indicator disc until symbol  (CLOSED) is in alignment with the ▲ mark on the cover.



3. Move actuator to end position OPEN.
4. Hold lower indicator disc in position and turn upper disc with symbol  (OPEN) until it is in alignment with the ▲ mark on the cover.



5. Move valve to end position CLOSED again.
6. Check settings:
If the symbol  (CLOSED) is no longer in alignment with ▲ mark on the cover:
→ Repeat setting procedure.

11.3.2. Gear stage of the reduction gearing: test/set

This test/setting is only required if a different swing angle is subsequently required:

Information The adjustable swing angle range is available in the order-related technical data sheet (e.g. "90° +/-15°").

1. Pull off indicator disc using a spanner as lever if required.

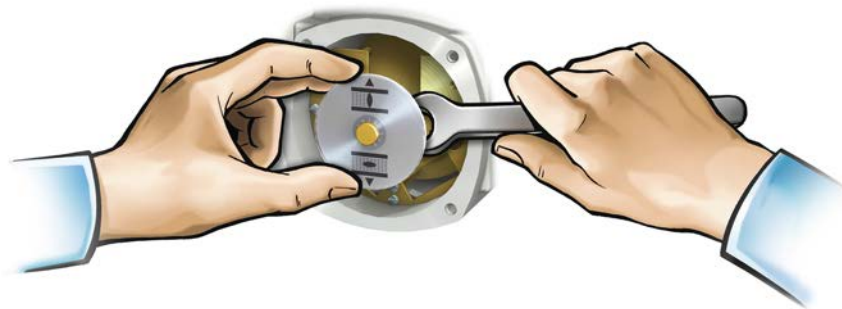

2. Refer to table and check if swing angle of the actuator corresponds to the setting of the reduction gearing (stages 1– 9).

If the setting is **not correct**: continue with step 4.

If the setting is correct: continue with step 7.

Table 26:

Actuator swing angle and suitable reduction gearing setting				
	SQ 05.2 / SQ 07.2	SQ 10.2	SQ 12.2	SQ 14.2
30° +/-15°	2	2	3	4
60° +/-15°	3	3	4	5
90° +/-15°	3	3	4	6
120° +/-15°	3	4	5	6
150° +/-15°	4	4	5	6
180° +/-15°	4	4	5	7
210° +/-15°	4	5	6	7
290° +/-70°	5	5	6	7

3. Loosen screw [1].
4. Set crown wheel [2] to desired stage according to table.
5. Tighten screw [1].
6. Place indicator disc on shaft.
7. Set mechanical position indicator.

Figure 72: Control unit with reduction gearing

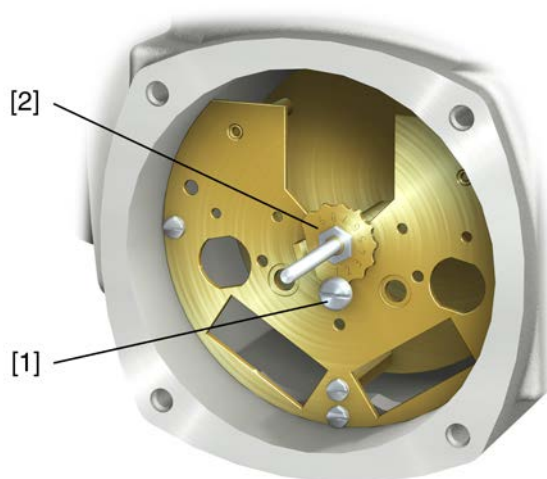

- [1] Screw
- [2] Crown wheel

12. Corrective action

12.1. Faults during commissioning

Table 27:

Faults during operation/commissioning		
Fault	Description/cause	Remedy
Mechanical position indicator cannot be set.	Reduction gearing is not suitable for actuator swing angle.	Set gear stage of the reduction gearing. The control unit might have to be exchanged.
In spite of correct setting of mechanical limit switching, actuator operates into the valve or actuator end position.	The overrun was not considered when setting the limit switching. The overrun is generated by the inertia of both the actuator and the valve and the delay time of the actuator controls.	<ul style="list-style-type: none"> Determine overrun: Overrun = travel covered from switching off until complete standstill. Set limit switching again considering the overrun. (Turn handwheel back by the amount of the overrun)

12.2. Fault indications and warning indications

Faults interrupt or prevent the electrical actuator operation. In the event of a fault, the display backlight is red.

Warnings have no influence on the electrical actuator operation. They only serve for information purposes. The display remains white.

Collective signals include further indications. They can be displayed via the  **Details** push button. The display remains white.

Table 28:







Faults and warnings via status indications in the display		
Indication on display	Description/cause	Remedy
S0001	Instead of the valve position, a status text is displayed.	For a description of the status texts, refer to Manual (Operation and setting).
S0005 Warnings	Collective signal 02: Indicates the number of active warnings.	For indicated value > 0: Press push button  Details . For details, refer to <Warnings and Out of specification> table.
S0006 Not ready REMOTE	Collective signal 04: Indicates the number of active signals.	For indicated value > 0: Press push button  Details . For details, refer to <Not ready REMOTE and Function check> table.
S0007 Fault	Collective signal 03: Indicates the number of active faults. The actuator cannot be operated.	For indicated value > 0: Press push button  Details to display a list of detailed indications. For details, refer to <Faults and Failure> table.
S0008 Out of specification	Collective signal 07: Indication according to NAMUR recommendation NE 107 Actuator is operated outside the normal operation conditions.	For indicated value > 0: Press push button  Details . For details, refer to <Warnings and Out of specification> table.
S0009 Function check	Collective signal 08: Indication according to NAMUR recommendation NE 107 The actuator is being worked on; output signals are temporarily invalid.	For indicated value > 0: Press push button  Details . For details, refer to <Not ready REMOTE and Function check> table.
S0010 Maintenance required	Collective signal 09: Indication according to NAMUR recommendation NE 107 Recommendation to perform maintenance.	For indicated value > 0: Press push button  Details to display a list of detailed indications.
S0011 Failure	Collective signal 10: Indication according to NAMUR recommendation NE 107 Actuator function failure, output signals are invalid	For indicated value > 0: Press push button  Details to display a list of detailed indications. For details, refer to <Faults and Failure> table.



Table 29:

Warnings and Out of specification		
Indication on display	Description/cause	Remedy
Config. warning	Collective signal 06: Possible cause: Configuration setting is incorrect. The device can still be operated with restrictions.	Press push button Details to display a list of individual indications. For a description of the individual signals, refer to Manual (Operation and setting).
Internal warning	Collective signal 15: Device warnings The device can still be operated with restrictions.	Press push button Details to display a list of individual indications. For a description of the individual signals, refer to Manual (Operation and setting).
24 V DC external	The external 24 V DC voltage supply of the controls has exceeded the power supply limits.	Check 24 V DC voltage supply.
Wrn op.mode run time	Warning on time max. running time/h exceeded	<ul style="list-style-type: none"> • Check modulating behaviour of actuator. • Check parameter Perm. run time M0356, re-set if required.
Wrn op.mode starts	Warning on time max. number of motor starts (starts) exceeded	<ul style="list-style-type: none"> • Check modulating behaviour of actuator. • Check parameter Permissible starts M0357, re-set if required.
Failure behav. active	The failure behaviour is active since all required setpoints and actual values are incorrect.	Verify signals: <ul style="list-style-type: none"> • Setpoint E1 • Actual value E2 • Actual process value E4 • Check connection to master.
Wrn input AIN 1	Warning: Loss of signal analogue input 1	Check wiring.
Wrn input AIN 2	Warning: Loss of signal analogue input 2	Check wiring.
Wrn setpoint position	Warning: Loss of signal setpoint position Possible causes: For an adjusted setpoint range of e.g. 4 – 20 mA, the input signal is 0 (signal loss). For a setpoint range of 0 – 20 mA , monitoring is not possible.	Check setpoint signal.
Op. time warning	The set time (parameter Perm.op. time, manual M0570) has been exceeded. The preset operating time is exceeded for a complete travel from end position OPEN to end position CLOSED.	The warning indications are automatically cleared once a new operation command is executed. <ul style="list-style-type: none"> • Check valve. • Check parameter Perm.op. time, manual M0570.
Wrn controls temp.	Temperature within controls housing too high.	Measure/reduce ambient temperature.
Time not set	Real time clock has not yet been set.	Set time.
RTC voltage	Voltage of the RTC button cell is too low.	Replace button cell.
PVST fault	Partial Valve Stroke Test (PVST) could not be successfully completed.	Check actuator (PVST settings).
PVST abort	Partial Valve Stroke Test (PVST) was aborted or could not be started.	Perform RESET or restart PVST.
Wrn no reaction	No actuator reaction to operation commands within the set reaction time.	<ul style="list-style-type: none"> • Check movement at actuator. • Check parameter Reaction time M0634.
Wrn FOC ¹⁾	Optical receiving signal (channel 1) incorrect (no or insufficient Rx receive level) or RS-485 format error (incorrect bit(s))	Check/repair FO cables.
Wrn FO cable budget ¹⁾	Warning: FO cable system reserve reached (critical or permissible Rx receive level)	Check/repair FO cables.
Wrn FOC connection ¹⁾	Warning FO cable connection is not available.	Fit FO cable connection.
Torque wrn OPEN	Limit value for torque warning in direction OPEN exceeded.	Check parameter Wrn torque OPEN M0768 , re-set if required.
Torque wrn CLOSE	Limit value for torque warning in direction CLOSE exceeded.	Check parameter Wrn torque CLOSE M0769 , re-set if required.

Warnings and Out of specification		
Indication on display	Description/cause	Remedy
SIL fault ²⁾	SIL sub-assembly fault has occurred.	Refer to separate Manual Functional Safety.
PVST required	Execution of PVST (Partial Valve Stroke Tests) is required.	
Maintenance required	Maintenance is required.	

- 1) For actuator controls with FOC connection
2) For actuators controls in SIL version

Table 30:

Faults and Failure		
Indication on display	Description/cause	Remedy
Configuration error	Collective signal 11: Configuration error has occurred.	Press push button  Details to display a list of individual indications. For a description of the individual signals, refer to Manual (Operation and setting).
Config. error REMOTE	Collective signal 22: Configuration error has occurred.	Press push button  Details to display a list of individual indications. For a description of the individual signals, refer to Manual (Operation and setting).
Internal error	Collective signal 14: Internal error has occurred.	AUMA service Press push button  Details to display a list of individual indications. For a description of the individual signals, refer to Manual (Operation and setting).
Torque fault CLOSE	Torque fault in direction CLOSE	Perform one of the following measures: <ul style="list-style-type: none"> Issue operation command in direction OPEN. Set selector switch to position Local control (LOCAL) and reset fault indication via push button RESET. Execute reset command via fieldbus.
Torque fault OPEN	Torque fault in direction OPEN	Perform one of the following measures: <ul style="list-style-type: none"> Issue operation command in direction CLOSE. Set selector switch to position Local control (LOCAL) and reset fault indication via push button RESET. Execute reset command via fieldbus.
Phase fault	<ul style="list-style-type: none"> When connecting to a 3-ph AC system and with internal 24 V DC supply of the electronics: Phase 2 is missing. When connecting to a 3-ph or 1-ph AC system and with external 24 V DC supply of the electronics: One of the phases L1, L2 or L3 is missing. 	Test/connect phases.
Incorrect phase seq	The phase conductors L1, L2 and L3 are connected in the wrong sequence. Only applicable if connected to a 3-ph AC system.	Correct the sequence of the phase conductors L1, L2 and L3 by exchanging two phases.
Mains quality	Due to insufficient mains quality, the controls cannot detect the phase sequence (sequence of phase conductors L1, L2 and L3) within the pre-set time frame provided for monitoring.	<ul style="list-style-type: none"> Check mains voltage. For 3-phase/1-phase AC current, the permissible variation of the mains voltage is $\pm 10\%$ (option $\pm 30\%$). The permissible variation of the mains voltage is $\pm 5\%$ Check parameter Tripping time M0172, extend time frame if required.

Faults and Failure		
Indication on display	Description/cause	Remedy
Thermal fault	Motor protection tripped	<ul style="list-style-type: none"> Cool down, wait. If the fault indication display persists after cooling down: <ul style="list-style-type: none"> Set selector switch to position Local control (LOCAL) and reset fault indication via push button RESET. Execute reset command via fieldbus. Check fuses.
Fault no reaction	No actuator reaction to operation commands within the set reaction time.	Check movement at actuator.
Poti Out of Range	Potentiometer is outside the permissible range.	Check device configuration: Parameter Low limit Uspan M0832 must be less than parameter Volt.level diff. potent. M0833 .
LPV not ready ¹⁾	LPV: Lift Plug Valve function The master actuator signals a fault	
Wrn input AIN 1	Loss of signal analogue input 1	Check wiring.
Wrn input AIN 2	Loss of signal analogue input 2	Check wiring.
Incorrect rotary direct.	Contrary to the configured direction of rotation and the active operation command, the motor turns into the wrong direction.	Check operation command control. For 3-phase AC current mains, activate phase monitoring (parameter Adapt rotary dir. M0171). Check device configuration setting (parameter Closing rotation M0176). To delete the fault indication: Disconnect actuator controls from the mains and perform reboot.
FQM collective fault ²⁾	Collective signal 25:	Press push button Details to display a list of individual indications. For a description of the individual signals, refer to Manual (Operation and setting).

1) For lift plug valve product variant

2) For actuators equipped with fail safe unit

Table 31:

Not ready REMOTE and Function check (collective signal 04)		
Indication on display	Description/cause	Remedy
Wrong oper. cmd	Collective signal 13: Possible causes: <ul style="list-style-type: none"> Several operation commands (e.g. OPEN and CLOSE simultaneously, or OPEN and SET-POINT operation simultaneously) A setpoint is present and the positioner is not active 	<ul style="list-style-type: none"> Check operation commands (reset/clear all operation commands and send one operation command only). Set parameter Positioner to Function active. Check setpoint. Press push button Details to display a list of individual indications. For a description of the individual signals, refer to Manual (Operation and setting).
Sel. sw. not REMOTE	Selector switch is not in position REMOTE.	Set selector switch to position REMOTE.
Service active	Operation via service interface (Bluetooth) and AUMA CDT service software.	Exit service software.
Disabled	Actuator is in operation mode Disabled.	Check setting and status of function <Local controls enable>.
EMCY stop active	The EMERGENCY stop switch has been operated. The motor control power supply (contactors or thyristors) is disconnected.	<ul style="list-style-type: none"> Enable EMERGENCY stop switch. Reset EMERGENCY stop state by means of Reset command.
EMCY behav. active	Operation mode EMERGENCY is active (EMERGENCY signal was sent). 0 V are applied at the EMERGENCY input.	<ul style="list-style-type: none"> Detect cause for EMERGENCY signal. Verify failure source. Apply +24 V DC at EMERGENCY input.
I/O interface	The actuator is controlled via the I/O interface (parallel).	Check I/O interface.
Handwheel active	Manual operation is activated.	Start motor operation.

Not ready REMOTE and Function check (collective signal 04)		
Indication on display	Description/cause	Remedy
FailState fieldbus	Fieldbus connection available, however no process data transmission by the master.	Verify master configuration
Local STOP	A local STOP is active. Push button STOP of local controls is operated.	Release push button STOP.
Interlock	An interlock is active.	Check interlock signal.
Interlock by-pass	By-pass function is interlocked.	Check states of main and by-pass valve.
PVST active	Partial Valve Stroke Test (PVST) is active.	Wait until PVST function is complete.
SIL function active ¹⁾	SIL function is active	

1) For actuators controls in SIL version

12.3. Fuses

12.3.1. Fuses within the actuator controls

F1/F2

Table 32:

Primary fuses F1/F2 (for power supply unit)		
G fuse	F1/F2	AUMA art. no.
Size	6.3 x 32 mm	
Reversing contactors Power supply ≤ 500 V	1 A T; 500 V	K002.277
Reversing contactors Power supply > 500 V	2 A FF; 690 V	K002.665
Thyristor units for motor power up to 1.5 kW	1 A T; 500 V	K002.277
Thyristor units for motor power up to 3.0 kW		
Thyristor units for motor power up to 5.5 kW		

F3 Internal 24 V DC supply

Table 33:

Secondary fuses F3 (internal 24 V DC supply)		
G fuse according to IEC 60127-2/III	F3	AUMA art. no.
Size	5 x 20 mm	
Voltage output (power supply unit) = 24 V	2.0 A T; 250 V	K006.106
Voltage output (power supply unit) = 115 V	2.0 A T; 250 V	K006.106

F4

Table 34:

Secondary fuse F4 (internal AC supply) ¹⁾		
G-fuse according to IEC 60127-2/III	F4	AUMA art. no.
Size	5 x 20 mm	
Voltage output (power supply unit) = 24 V	1.25 A T; 250 V	K001.184
Voltage output (power supply unit) = 115 V	—	—

1) Fuse for: Switch compartment heater, reversing contactor control, PTC tripping device (at 24 V AC only), at 115 V AC also control inputs OPEN, STOP, CLOSE

F5 Automatic reset fuse as short-circuit protection for external 24 V DC supply for customer (see wiring diagram)

12.3.2. Fuse replacement

12.3.2.1. Replace fuses F1/F2



Electric shock due to presence of hazardous voltage!

Death or serious injury.

→ Disconnect device from the mains before opening.

1. Remove electrical connection from actuator controls.

Figure 73:

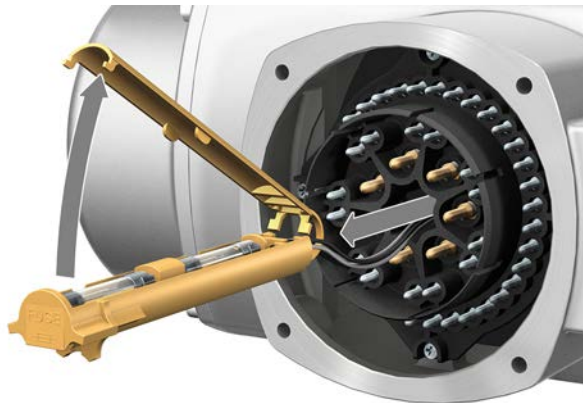

2. Pull fuse holder out of pin carrier, open fuse cover and replace old fuses by new ones.

12.3.2.2. Test/replace fuses F3/F4

1. Loosen screws [1] and remove cover [2] on the rear of the actuator controls.

Figure 74:

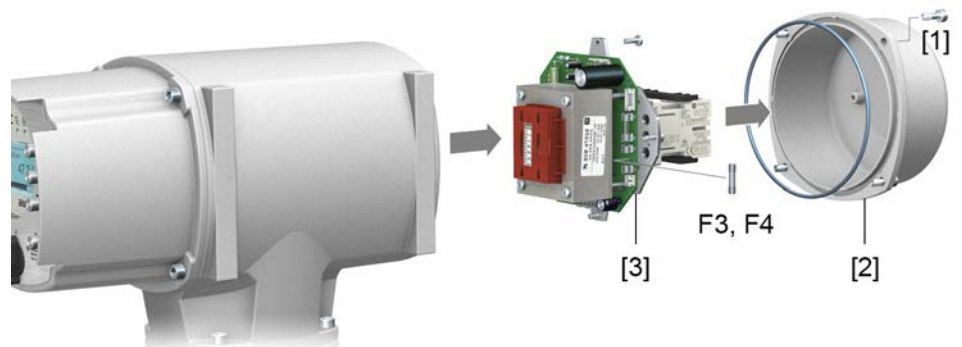

- Check fuses.**
2. The power supply unit has measuring points (solder pins) allowing to perform a resistance (continuity) measurement:

Table 35:

Checking	Measuring points
F3	MTP5 – MTP6
F4	MTP7 – MTP8

3. To replace defective fuses: Carefully loosen power supply unit [3] and pull out. (The fuses are on the equipped part of the power supply board.)



Cable damage due to pinching!

Risk of functional failures.

→ Carefully assemble power supply unit to avoid pinching the cables.

12.3.3. Motor protection (thermal monitoring)

In order to protect against overheating and impermissibly high surface temperatures at the actuator, PTC thermistors or thermostats are embedded in the motor winding. Motor protection trips as soon as the max. permissible winding temperature has been reached.

The actuator is switched off and the following signals are given:

- LED 3 (motor protection tripped) on the local controls is illuminated.
- The status indications **S0007** or **S0011 Failure** display a fault. The fault **Details** is displayed when selecting **Thermal fault**.

The motor has to cool down before operation can be resumed.

Depending on the parameter setting (motor protection behaviour), the fault signal is either automatically reset or the fault signal has to be acknowledged.

The acknowledgement is made:

- in selector switch position **Local control** (LOCAL) via push button **RESET**.
- In selector switch position **Remote control** (REMOTE) with Reset command via fieldbus.

Proof-test motor protection

Correct function of the motor protection can be tested.

Information For weatherproof actuator controls mounted on wall bracket controlling an explosion-proof actuator, the functionality of the motor protection must be verified at the latest when performing the maintenance (refer to chapter <Servicing and maintenance>).

The test is performed by simulating the motor protection signal via actuator controls local controls:

Required user level: **Specialist (4)** or higher.

M ▷ **Diagnostics M0022**
TMS proof test M1950

- Test procedure:**
1. Set selector switch to position **0** (OFF).
 2. Return to the main menu and select the simulation value in parameter **TMS proof test M1950**: Select **Thermal test**.
 3. Activate motor protection simulation: Press **Ok** push button. The safety function is correct if no fault signal is displayed.
 4. Reset simulation: Press **Ok** push button or exit the simulation menu and reset the selector switch to its initial position.

13. Servicing and maintenance



Damage caused by inappropriate maintenance!

- Servicing and maintenance must be carried out exclusively by suitably qualified personnel having been authorised by the end user or the contractor of the plant. Therefore, we recommend contacting our service.
- Only perform servicing and maintenance tasks when the device is switched off.

AUMA Service & Support

AUMA offers extensive service such as servicing and maintenance as well as customer product training. For the contact addresses, refer to our website (www.auma.com).

13.1. Preventive measures for servicing and safe operation

The following actions are required to ensure safe device operation:

6 months after commissioning and then once a year

- Carry out visual inspection:
Cable entries, cable glands, blanking plugs, etc. have to be checked for correct fit and sealing. If required, tighten cable glands and blanking plugs with torque in compliance with the manufacturer's specifications.
Check actuator for damage as well as for grease or oil leakage.
- When deployed in areas where dust formation represents a potential explosion hazard, perform visual inspection for deposit of dirt or dust on a regular basis. Clean devices if required.
- Check fastening screws between actuator and gearbox/valve for tightness. If required, fasten screws while applying the tightening torques as indicated in chapter <Assembly>.
- When rarely operated: Perform test run.

For enclosure protection IP68

After submersion:

- Check actuator.
- In case of ingress of water, locate leaks and repair. Dry device correctly and check for proper function.

13.2. Maintenance

Manual operation

During maintenance, the mechanical parts of the handwheel activation, in particular motor coupling and retaining spring, must be checked. Replace the parts in case of visible wear.

Lubrication

- In the factory, the gear housing is filled with grease.
- Additional lubrication of the gear housing is not required during operation.
- Grease change is performed during maintenance
 - Generally after 4 to 6 years for modulating duty.
 - Generally after 6 to 8 years if operated frequently (open-close duty).
 - Generally after 10 to 12 years if operated infrequently (open-close duty).
- We recommend replacing the seals when changing the grease.

13.3. Disposal and recycling

Our devices have a long lifetime. However, they have to be replaced at one point in time. The devices have a modular design and may, therefore, easily be separated and sorted according to materials used, i.e.:

- Electronic scrap
- Various metals

- Plastic materials
- Greases and oils

The following generally applies:

- Greases and oils are hazardous to water and must not be released into the environment.
- Arrange for controlled waste disposal of the disassembled material or for separate recycling according to materials.
- Observe the national regulations for waste disposal.

14. Technical data

Information The following tables include standard and optional features. For detailed information on the customer-specific version, refer to the order-related data sheet. The technical data sheet can be downloaded from the Internet in both German and English at <http://www.auma.com> (please state the order number).

14.1. Technical data Part-turn actuator

Features and functions	
Type of duty (Part-turn actuators for open-close duty)	with 3-phase AC motor: Short-time duty S2 - 15 min, classes A and B according to EN 15714-2 with 1-phase AC motor: Short-time duty S2 - 10 min, classes A and B according to EN 15714-2 For nominal voltage, +40 °C ambient temperature and at load with 35 % of the max. torque
Type of duty (Part-turn actuators for modulating duty)	Standard: with 3-phase AC motor: Intermittent duty S4 - 25 %, class C according to EN 15714-2 with 1-phase AC motor: Intermittent duty S4 - 20%, class C according to EN 15714-2 Option: With 3-phase AC motor: Intermittent duty S4 - 50 %, class C according to EN 15714-2 For nominal voltage, +40 °C ambient temperature and at modulating torque load.
Motors	Standard: 3-phase AC asynchronous motor, type IM B9 according to IEC 60034-7, IC410 cooling procedure according to IEC 60034-6 Option: 1-phase AC motor with integral permanent split capacitor (PSC), type IM B9 according to IEC 60034-7, IC410 cooling procedure according to IEC 60034-6
Mains voltage, mains frequency	Refer to motor name plate Permissible variation of mains voltage: ±10 % Permissible variation of mains frequency: ±5 %
Overvoltage category	Category III according to IEC 60364-4-443
Insulation class	Standard: F, tropicalized Option: H, tropicalized
Motor protection	Standard: Thermostats (NC) Option: PTC thermistors (according to DIN 44082)
Motor heater (option)	Voltages: 110 – 120 V AC, 220 – 240 V AC or 380 – 480 V AC for 3-phase AC motors Power: 12.5 W
Swing angle	Standard: Adjustable between 75° and < 105° Option: 15° to < 45°, 45° to < 75°, 105° to < 135°, 135° to < 165°, 165° to < 195°, 195° to < 225°
Self-locking	Yes (Part-turn actuators are self-locking if the valve position cannot be changed from standstill while torque acts upon the output drive.)
Manual operation	Manual drive for setting and emergency operation, handwheel does not rotate during electrical operation. Option: Handwheel lockable Handwheel stem extension Power tool for emergency operation with square 30 mm or 50 mm
Indication for manual operation (option)	Indication whether manual operation is active/not active via single switch (1 change-over contact)
Splined coupling for connection to the valve shaft	Standard: Coupling without bore Options: Machined coupling with bore and keyway, square bore or bore with two-flats according to EN ISO 5211
Valve attachment	Dimensions according to EN ISO 5211 without spigot

With base and lever (option)	
Swing lever	Made of spheroidal cast iron with two or three bores for fixing a lever arrangement. Considering the installation conditions, the lever may be mounted to the output shaft in any desired position.
Ball joints (option)	Two ball joints matching the lever, including lock nuts and two welding nuts, suitable for pipe according to dimension sheet
Fixing	Base with four holes for fastening screws

Electronic control unit	
Non-Intrusive setting	Magnetic limit and torque transmitter (MWG)
Position feedback signal	Via actuator controls
Torque feedback signal	Via actuator controls
Mechanical position indicator	Continuous self-adjusting indication with symbols OPEN and CLOSED
Running indication	Blinking signal via actuator controls
Heater in switch compartment	Resistance type heater with 5 W, 24 V AC

Service conditions	
Use	Indoor and outdoor use permissible
Mounting position	Any position
Installation altitude	≤ 2,000 m above sea level > 2,000 m above sea level on request
Ambient temperature	Refer to actuator name plate
Humidity	Up to 100 % relative humidity across the entire permissible temperature range
Enclosure protection according to EN 60529	Standard: IP68 with AUMA 3-phase AC motor/1-phase AC motor For special motors differing enclosure protection available (refer to motor name plate)
	Option: Terminal compartment additionally sealed against interior of actuator (double sealed)
	According to AUMA definition, enclosure protection IP68 meets the following requirements: <ul style="list-style-type: none"> • Depth of water: maximum 8 m head of water • Duration of continuous immersion in water: Max. 96 hours • Up to 10 operations during immersion • Modulating duty is not possible during immersion For exact version, refer to actuator controls name plate.
Pollution degree according to IEC 60664-1	Pollution degree 4 (when closed), pollution degree 2 (internal)
Vibration resistance according to IEC 60068-2-6	2 g, 10 to 200 Hz (AUMA NORM), 1 g, 10 to 200 Hz (for actuators with AM or AC integral controls) Resistant to vibration during start-up or for failures of the plant. However, a fatigue strength may not be derived from this. Valid for part-turn actuators in version AUMA NORM and in version with integral actuator controls, each with AUMA plug/socket connector. Not valid in combination with gearboxes.
Corrosion protection	Standard: KS: Suitable for use in areas with high salinity, almost permanent condensation, and high pollution.
	Option: KX: Suitable for use in areas with extremely high salinity, permanent condensation, and high pollution. KX-G: Same as KX, however aluminium-free version (outer parts)
Coating	Double layer powder coating Two-component iron-mica combination
Colour	Standard: AUMA silver-grey (similar to RAL 7037)
	Option: Available colours on request
Lifetime	AUMA part-turn actuators meet or even exceed the lifetime requirements of EN 15714-2. Detailed information can be provided on request.

Further information	
EU Directives	Machinery Directive 2006/42/EC Low Voltage Directive 2014/35/EU EMC Directive 2014/30/EU RoHS Directive 2011/65/EU RED Directive 2014/53/EU

Technical data for handwheel activation switches	
Mechanical lifetime	10 ⁶ starts
Silver plated contacts:	
U min.	12 V DC
U max.	250 V AC
I max. AC current	3 A at 250 V (inductive load, cos phi = 0.8)
I max. DC current	3 A at 12 V (resistive load)

14.2. Technical data Actuator controls

Features and functions	
Power supply	Refer to name plate Permissible variation of mains voltage: ±10 % Permissible variation of mains voltage: ±30 % (option) Permissible variation of mains frequency: ±5 %
External supply of the electronics (option)	24 V DC: +20 %/-15 % Current consumption: Basic version approx. 250 mA, with options up to 500 mA For external electronics supply, the power supply of integral controls must have an enhanced isolation against mains voltage in compliance with IEC 61010-1 and the output power be limited to 150 VA.
Current consumption	Current consumption of the actuator controls depending on mains voltage: For permissible variation of mains voltage of ±10 %: <ul style="list-style-type: none"> • 100 to 120 V AC = max. 740 mA • 208 to 240 V AC = max. 400 mA • 380 to 500 V AC = max. 250 mA • 515 V AC = max. 200 mA For permissible variation of mains voltage of ±30 %: <ul style="list-style-type: none"> • 100 to 120 V AC = max. 1,200 mA • 208 to 240 V AC = max. 750 mA • 380 to 500 V AC = max. 400 mA • 515 to 690 V AC = max. 400 mA
Overvoltage category	Category III according to IEC 60364-4-443
Rated power	The actuator controls are designed for the nominal motor power, refer to motor name plate
Switchgear	Standard: Reversing contactors (mechanically and electrically interlocked) for AUMA power classes A1/A2 Options: Reversing contactors (mechanically and electrically interlocked) for AUMA power class A3 Thyristor unit for mains voltage up to 500 V AC (recommended for modulating actuators) for AUMA power classes B1, B2 and B3 The reversing contactors are designed for a lifetime of 2 million starts. For applications requiring a high number of starts, we recommend the use of thyristor units. For the assignment of AUMA power classes, please refer to Electrical data on actuator
Control and feedback signals	Via Modbus RTU interface

Features and functions	
Fieldbus interface with additional input signals (option)	<ul style="list-style-type: none"> • 2 free analogue inputs (0/4 – 20 mA), 4 free digital inputs <ul style="list-style-type: none"> - Signal transmission is made via fieldbus interface • Inputs OPEN, STOP, CLOSE, EMERGENCY, I/O interface, MODE (via opto-isolator thereof OPEN, STOP, CLOSE, MODE with one common and EMERGENCY, I/O interface respectively without common) <ul style="list-style-type: none"> - OPEN, STOP, CLOSE, EMERGENCY control inputs - I/O interface: Selection of control type (fieldbus interface or additional input signals) - MODE: Selection between open-close duty (OPEN, STOP, CLOSE) or modulating duty (0/4 – 20 mA position setpoint) - Additionally 1 analogue input (0/4 – 20 mA) for position setpoint • Inputs OPEN, STOP, CLOSE, EMERGENCY, I/O interface, MODE (via opto-isolator thereof OPEN, STOP, CLOSE, MODE with one common and EMERGENCY, I/O interface respectively without common) <ul style="list-style-type: none"> - OPEN, STOP, CLOSE, EMERGENCY control inputs - I/O interface: Selection of control type (fieldbus interface or additional input signals) - MODE: Selection between open-close duty (OPEN, STOP, CLOSE) or modulating duty (0/4 – 20 mA position setpoint) - Additionally 1 analogue input (0/4 – 20 mA) for setpoint position and 1 analogue input (0/4 – 20 mA) for actual process value
Control voltage/current consumption for control inputs	Standard: 24 V DC, current consumption: approx. 10 mA per input
	Options: 48 V DC, current consumption: approx. 7 mA per input 60 V DC, current consumption: approx. 9 mA per input 100 – 125 V DC, current consumption: approx. 15 mA per input 100 – 120 V AC, current consumption : approx. 15 mA per input
	All input signals must be supplied with the same potential.
Status signals	Via Modbus RTU interface
Fieldbus interface with additional output signals (option)	<p>Additional, binary output signals (only available in combination with additional input signals (option)) These output signals are not available via DeviceNet interface.</p> <ul style="list-style-type: none"> • 6 programmable output contacts: <ul style="list-style-type: none"> - 5 potential-free NO contacts with one common, max. 250 V AC, 1 A (resistive load) Default configuration: End position CLOSED, end position OPEN, selector switch REMOTE, torque fault CLOSE, torque fault OPEN - 1 potential-free change-over contact, max. 250 V AC, 5 A (resistive load) Default configuration: Collective fault signal (torque fault, phase failure, motor protection tripped) • 6 programmable output contacts: <ul style="list-style-type: none"> - 5 potential-free change-over contacts with one common, max. 250 V AC, 1 A (resistive load) - 1 potential-free change-over contact, max. 250 V AC, 5 A (resistive load) • 6 programmable output contacts: <ul style="list-style-type: none"> - 6 potential-free change-over contacts without one common, max. 250 V AC, 5 A (resistive load) • 6 programmable output contacts: <ul style="list-style-type: none"> - 4 mains failure proof potential-free NO contacts with one common, max. 250 V AC, 1 A (resistive load), 1 potential-free NO contact, max. 250 V AC, 1 A (resistive load), 1 potential-free change-over contact, max. 250 V AC, 5 A (resistive load) • 6 programmable output contacts: <ul style="list-style-type: none"> - 4 mains failure proof potential-free NO contacts, max. 250 V AC, 5 A (resistive load), 2 potential-free change-over contacts, max. 250 V AC, 5 A (resistive load), <p>All binary output signals must be supplied with the same potential.</p> <ul style="list-style-type: none"> • Analogue output signal for position feedback <ul style="list-style-type: none"> - Galvanically isolated position feedback 0/4 – 20 mA (load max. 500 Ω)
Voltage output	Standard: Auxiliary voltage 24 V DC: max. 100 mA for supply of control inputs, galvanically isolated from internal voltage supply.
	Option: Auxiliary voltage 115 V AC: max. 30 mA for supply of control inputs, galvanically isolated from internal voltage supply (Not possible in combination with PTC tripping device)

Features and functions	
Redundancy (option)	<p>Redundant line topology with universal redundancy behaviour according to AUMA redundancy I or II Redundant loop topology in combination with SIMA² Master Station</p> <ul style="list-style-type: none"> • Max. number of actuators with actuator controls per redundant loop: 247 units • Max. possible cable length between the actuators equipped with actuator controls without external repeater: 1,200 m • Max. possible total length per redundant ring: approx. 290 km • Automatic commissioning of the redundant loop by means of the SIMA² Master Station
FO cable connection (option)	<ul style="list-style-type: none"> • Connector types: ST or SC connector • FO cables <ul style="list-style-type: none"> - Multi-mode: 62,5(50)/125 µm, range approx. 2.5 km (max. 2.0 dB/km) - Single-mode: 9/125 µm, range approx. 15 km (max. 0.4 dB/km) • Topologies: Line, star and redundant ring (with single-channel Modbus RTU interface) • Baud rate: up to 115.2 kbit/s • Optical budget: <ul style="list-style-type: none"> - Multi-mode: 13 dB - Single-mode: 17 dB • Wave length: 1,310 nm • FO coupler by EKS required at DCS, reference addresses: AUMA or www.eks-engel.com
Local controls	<p>Standard:</p> <ul style="list-style-type: none"> • Selector switch: LOCAL - OFF - REMOTE (lockable in all three positions) • Push buttons OPEN, STOP, CLOSE, RESET <ul style="list-style-type: none"> - Local STOP The actuator can be stopped via push button STOP of local controls if the selector switch is in position REMOTE. (Not activated when leaving the factory.) • 6 indication lights: <ul style="list-style-type: none"> - End position and running indication CLOSED (yellow), torque fault CLOSE (red), motor protection tripped (red), torque fault OPEN (red), end position and running indication OPEN (green), Bluetooth (blue) • Graphic LC display: illuminated
	<p>Option:</p> <ul style="list-style-type: none"> • Special colours for the indication lights: <ul style="list-style-type: none"> - End position CLOSED (green), torque fault CLOSE (blue), torque fault OPEN (yellow), motor protection tripped (violet), end position OPEN (red)
Bluetooth Communication interface	<p>Bluetooth Class II Chip, Version 2.1: With a range up to 10 m in industrial environments supports the SSP Bluetooth profile (Serial Port Profile).</p> <p>Required accessories:</p> <ul style="list-style-type: none"> • AUMA CDT (Commissioning and Diagnostic Tool for Windows-based PC) • AUMA Assistant App (Commissioning and Diagnostic Tool)
Application functions	<p>Standard:</p> <ul style="list-style-type: none"> • Selectable type of seating, limit or torque seating for end position OPEN and end position CLOSED • Torque by-pass: Adjustable duration (with adjustable peak torque during start-up time) • Start and end of stepping mode as well as ON and OFF times can be set individually for directions OPEN and CLOSE, 1 to 1,800 seconds • Any 8 intermediate positions: can be set between 0 and 100 %, reaction and signal behaviour programmable • Running indication blinking: can be set • Positioner <ul style="list-style-type: none"> - Position setpoint via Modbus RTU interface - Programmable behaviour on loss of signal - Automatic adaptation of dead band (adaptive behaviour selectable) - Split range operation - Change-over between OPEN-CLOSE control and setpoint control possible via fieldbus interface
	<p>Options:</p> <ul style="list-style-type: none"> • PID process controller: with adaptive positioner, via 0/4 – 20 mA analogue inputs for process setpoint and actual process value • Automatic deblocking: Up to 5 operation trials, travel time in opposite direction can be set • Static and dynamic torque recording for both rotation directions with torque measurement flange as additional accessory

Features and functions	
Safety functions	<p>Standard:</p> <ul style="list-style-type: none"> EMERGENCY operation (programmable behaviour) <ul style="list-style-type: none"> Via additional input (option, low active) or via Fieldbus interface Reaction can be selected: Stop, run to end position CLOSED, run to end position OPEN, run to intermediate position Torque monitoring can be by-passed during EMERGENCY operation Thermal protection can be by-passed during EMERGENCY operation (only in combination with thermoswitch within actuator, not with PTC thermistor). <p>Options:</p> <ul style="list-style-type: none"> Release of local controls via fieldbus interface. Thus, actuator operation can be enabled or disabled via push buttons on local controls. Local STOP <ul style="list-style-type: none"> The actuator can be stopped via push button Stop of local controls if the selector switch is in position REMOTE. (Not activated when leaving the factory.) Interlock for main/by-pass valve: Enabling the operation commands OPEN or CLOSE via fieldbus interface EMERGENCY Stop push button (latching): Interrupts electrical operation, irrespective of the selector switch position PVST (Partial Valve Stroke Test): programmable to check the function of both actuator and actuator controls: Direction, stroke, operation time, reversing time
Monitoring functions	<ul style="list-style-type: none"> Valve overload protection: Adjustable, results in switching off and generates fault signal Motor temperature monitoring (thermal monitoring): Results in switching off and generates fault signal Monitoring the heater within actuator: Generates warning signal Monitoring of permissible on-time and number of starts: Adjustable, generates warning signal Operating time monitoring: Adjustable, generates warning signal Phase failure monitoring: Results in switching off and generates fault signal Automatic correction of rotation direction upon wrong phase sequence (3-ph AC current)
Diagnostic functions	<ul style="list-style-type: none"> Electronic device ID with order and product data Operating data logging: A resettable counter and a lifetime counter each for: <ul style="list-style-type: none"> Motor running time, number of starts, torque switch trippings in end position CLOSED, limit switch trippings in end position CLOSED, torque switch trippings in end position OPEN, limit switch trippings in end position OPEN, torque faults CLOSE, torque faults OPEN, motor protection trippings Time-stamped event report with history for setting, operation and faults Status signals according to NAMUR recommendation NE 107: "Failure", "Function check", "Out of specification", "Maintenance required" Torque characteristics (for version with MWG in actuator): <ul style="list-style-type: none"> 3 torque characteristics (torque-travel characteristic) for opening and closing directions can be saved separately. Torque characteristics stored can be shown on the display.
Motor protection evaluation	<p>Standard: Monitoring the motor temperature in combination with thermoswitches within actuator motor</p> <p>Options:</p> <ul style="list-style-type: none"> Thermal overload relay in controls combined with thermoswitches within actuator PTC tripping device in combination with PTC thermistors within actuator motor
Overvoltage protection (option)	Protection of the actuator and control electronics against overvoltages on the fieldbus cables of up to 4 kV
Electrical connection	<p>Standard: AUMA plug/socket connector with screw-type connection</p> <p>Option: Gold-plated control plug (sockets and plugs)</p>
Threads for cable entries	<p>Standard: Metric threads</p> <p>Options:</p> <ul style="list-style-type: none"> Pg-threads, NPT-threads, G-threads Terminals or crimp-type connection
Wiring diagram	Refer to name plate
Further options for Non-intrusive version with MWG in the actuator	
Setting of limit and torque switching via local controls	
Torque feedback signal	Via Modbus RTU interface Galvanically isolated analogue output 0/4 – 20 mA (load max. 500 Ω). Option, only possible in combination with output contacts.

Settings/programming the Modbus RTU interface			
Setting the Modbus RTU interface	Baud rate, parity and Modbus address are set via the display of actuator controls		
General data of the Modbus RTU interface			
Communication protocol	Modbus RTU according to IEC 61158 and IEC 61784		
Network topology	<ul style="list-style-type: none"> Line (fieldbus) structure. When using repeaters, tree structures can also be implemented. Coupling and uncoupling of devices during operation without affecting other devices is possible. 		
Transmission medium	Twisted, screened copper cable according to IEC 61158		
Fieldbus interface	EIA-485 (RS-485)		
Transmission rate/cable length	Redundant line topology:		
	Baud rate (kbit/s)	Max. cable length (segment length) without repeater	Possible cable length with repeater (total network cable length)
	9.6 – 115.2	1,200 m	approx. 10 km
	Redundant ring topology:		
	Baud rate (kbit/s)	Max. cable length between actuators (without repeater)	Max. possible cable length of redundant loop
	9.6 – 115.2	1,200 m	approx. 290 km
Device types	Modbus slave, e.g. devices with digital and/or analogue inputs/outputs such as actuators, sensors		
Number of devices	32 devices in each segment without repeater, with repeaters expandable to 247		
Fieldbus access	Polling between master and slaves (query response)		
Supported Modbus functions (services)	01 Read Coil Status 02 Read Input Status 03 Read Holding Registers 04 Read Input Registers 05 Force Single Coil 15 (0FHex) Force Multiple Coils 06 Preset Single Register 16 (10Hex) Preset Multiple Registers 17 (11Hex) Report Slave ID 08 Diagnostics: <ul style="list-style-type: none"> 00 00 Loopback 00 10 (0AHex) Clear Counters and Diagnostic Register 00 11 (0BHex) Return Bus Message Count 00 12 (0CHex) Return Bus Communication Error Count 00 13 (0DHex) Return Bus Exception Error Count 00 14 (0EHex) Return Slave Message Count 00 15 (0FHex) Return Slave No Response Count 00 16 (10Hex) Return Slave NAK Count 00 17 (11Hex) Return Slave Busy Count 00 18 (12Hex) Return Character Overrun Count 		

Commands and signals of the Modbus RTU interface	
Process representation output (command signals)	OPEN, STOP, CLOSE, position setpoint, RESET, EMERGENCY operation command, enable LOCAL, Interlock OPEN/CLOSE
Process representation input (feedback signals)	<ul style="list-style-type: none"> • End positions OPEN, CLOSED • Actual position value • Actual torque value, requires MWG in actuator • Selector switch in position LOCAL/REMOTE • Running indication (directional) • Torque switches OPEN, CLOSED • Limit switches OPEN, CLOSED • Manual operation by handwheel or via local controls • Analogue (2) and digital (4) customer inputs
Process representation input (fault signals)	<ul style="list-style-type: none"> • Motor protection tripped • Torque switch tripped in mid-travel • One phase missing • Failure of analogue customer inputs
Behaviour on loss of communication	<p>The behaviour of the actuator is programmable:</p> <ul style="list-style-type: none"> • Stop in current position • Travel to end position OPEN or CLOSED • Travel to any intermediate position • Execute last received operation command

Service conditions	
Use	Indoor and outdoor use permissible
Mounting position	Any position
Installation altitude	<p>≤ 2 000 m above sea level</p> <p>> 2,000 m above sea level, on request</p>
Ambient temperature	Refer to name plate of actuator controls
Humidity	Up to 100 % relative humidity across the entire permissible temperature range
Enclosure protection in accordance with IEC 60529	Standard: IP68
	Option: Terminal compartment additionally sealed against interior of actuator controls (double sealed)
	<p>According to AUMA definition, enclosure protection IP68 meets the following requirements:</p> <ul style="list-style-type: none"> • Depth of water: Maximum 8 m head of water • Continuous immersion in water: maximal 96 hours • Up to 10 operations during immersion • Modulating duty is not possible during immersion. <p>For exact version, refer to actuator controls name plate.</p>
Pollution degree according to IEC 60664-1	Pollution degree 4 (when closed), pollution degree 2 (internal)
Vibration resistance according to IEC 60068-2-6	<p>1 g, from 10 Hz to 200 Hz</p> <p>Resistant to vibration during start-up or for failures of the plant. However, a fatigue strength may not be derived from this. (Not valid in combination with gearboxes)</p>
Corrosion protection	Standard: KS: Suitable for use in areas with high salinity, almost permanent condensation, and high pollution.
	Option: KX: Suitable for use in areas with extremely high salinity, permanent condensation, and high pollution.
Coating	<p>Double layer powder coating</p> <p>Two-component iron-mica combination</p>
Colour	Standard: AUMA silver-grey (similar to RAL 7037)
	Option: Available colours on request

Accessories	
Wall bracket	For actuator controls mounted separately from the actuator, including plug/socket connector. Connecting cable on request. Recommended for high ambient temperatures, difficult access, or in case of heavy vibration during service. Cable length between actuator and actuator controls is max. 100 m. An MWG is required for position feedback.
Programming software	AUMA CDT (Commissioning and Diagnostic Tool for Windows-based PC) AUMA Assistant App (Commissioning and Diagnostic Tool)
Torque measurement flange DMF	Accessory for torque measurement for SA/SAR 07.2 – SA/SAR 16.2

Further information	
Weight	Approx. 7 kg (with AUMA plug/socket connector)
EU Directives	Machinery Directive 2006/42/EC Low Voltage Directive 2014/35/EU EMC Directive 2014/30/EU RoHS Directive 2011/65/EU

14.3. Tightening torques for screws

Table 36:

Tightening torques for screws		
Threads	Tightening torque [Nm]	
	Strength class	
	A2-70/A4-70	A2-80/A4-80
M6	7.4	10
M8	18	24
M10	36	48
M12	61	82
M16	150	200
M20	294	392
M30	1,015	1,057
M36	1,769	2,121

15. Spare parts

15.1. Part-turn actuators SQ 05.2 – SQ 14.2/SQR 05.2 – SQR 14.2

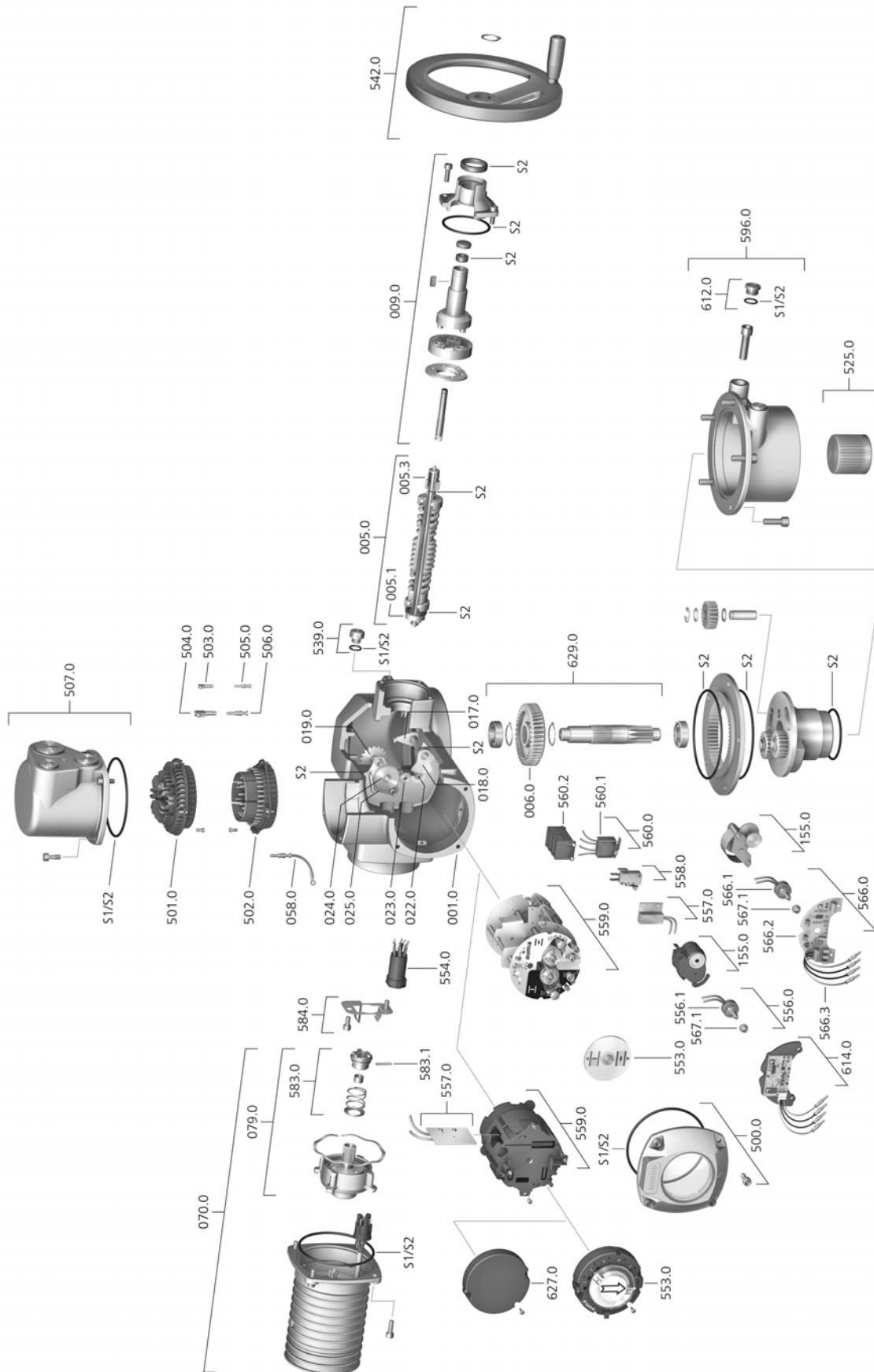

Please state device type and our order number (see name plate) when ordering spare parts. Only original AUMA spare parts should be used. Failure to use original spare parts voids the warranty and exempts AUMA from any liability. Representation of spare parts may slightly vary from actual delivery.

Ref. no.	Designation	Type	Ref. no.	Designation	Type
001.0	Housing	Sub-assembly	553.0	Mechanical position indicator	Sub-assembly
005.0	Drive shaft	Sub-assembly	554.0	Socket carrier for motor plug/socket connector with cable harness	Sub-assembly
005.1	Motor coupling	Sub-assembly	556.0	Potentiometer as position transmitter	Sub-assembly
005.3	Manual drive coupling		556.1	Potentiometer without slip clutch	Sub-assembly
006.0	Worm wheel	Sub-assembly	557.0	Heater	Sub-assembly
009.0	Manual gearing	Sub-assembly	558.0	Blinker transmitter including pins at wires (without impulse disc and insulation plate)	Sub-assembly
017.0	Torque lever		559.0–1	Electromechanical control unit with switches, including torque switching heads	Sub-assembly
018.0	Gear segment	Sub-assembly	559.0–2	Electronic control unit with magnetic limit and torque transmitter (MWG)	Sub-assembly
019.0	Crown wheel		560.0–1	Switch stack for direction OPEN	Sub-assembly
022.0	Drive pinion II for torque switching	Sub-assembly	560.0–2	Switch stack for direction CLOSE	Sub-assembly
023.0	Output drive wheel for limit switching	Sub-assembly	560.1	Switch for limit/torque	Sub-assembly
024.0	Drive wheel for limit switching	Sub-assembly	560.2–1	Switch case for direction OPEN	
025.0	Locking plate	Sub-assembly	560.2–2	Switch case for direction CLOSE	
058.0	Cable for protective earth	Sub-assembly	566.0	RWG position transmitter	Sub-assembly
070.0	Motor (incl. ref. no. 079.0)	Sub-assembly	566.1	Potentiometer for RWG without slip clutch	Sub-assembly
079.0	Planetary gearing for motor drive	Sub-assembly	566.2	Position transmitter board for RWG	Sub-assembly
155.0	Reduction gearing	Sub-assembly	566.3	Cable set for RWG	Sub-assembly
500.0	Cover	Sub-assembly	567.1	Slip clutch for potentiometer	Sub-assembly
501.0	Socket carrier (complete with sockets)	Sub-assembly	583.0	Motor coupling on motor shaft	Sub-assembly
502.0	Pin carrier without pins	Sub-assembly	583.1	Pin for motor coupling	Sub-assembly
503.0	Socket for controls	Sub-assembly	584.0	Retaining spring for motor coupling	
504.0	Socket for motor		596.0	Output drive flange with end stop	Sub-assembly
505.0	Pin for controls	Sub-assembly	612.0	Screw plug for end stop	Sub-assembly
506.0	Pin for motor	Sub-assembly	614.0	EWG position transmitter	Sub-assembly
507.0	Cover for electrical connection	Sub-assembly	627.0	MWG 05.03 cover	
525.0	Coupling	Sub-assembly	629.0	Pinion shaft	Sub-assembly
539.0	Screw plug	Sub-assembly	S1	Seal kit, small	Set
542.0	Handwheel with ball handle		S2	Seal kit, large	Set

15.2. AC 01.2 actuator controls with SD electrical connection

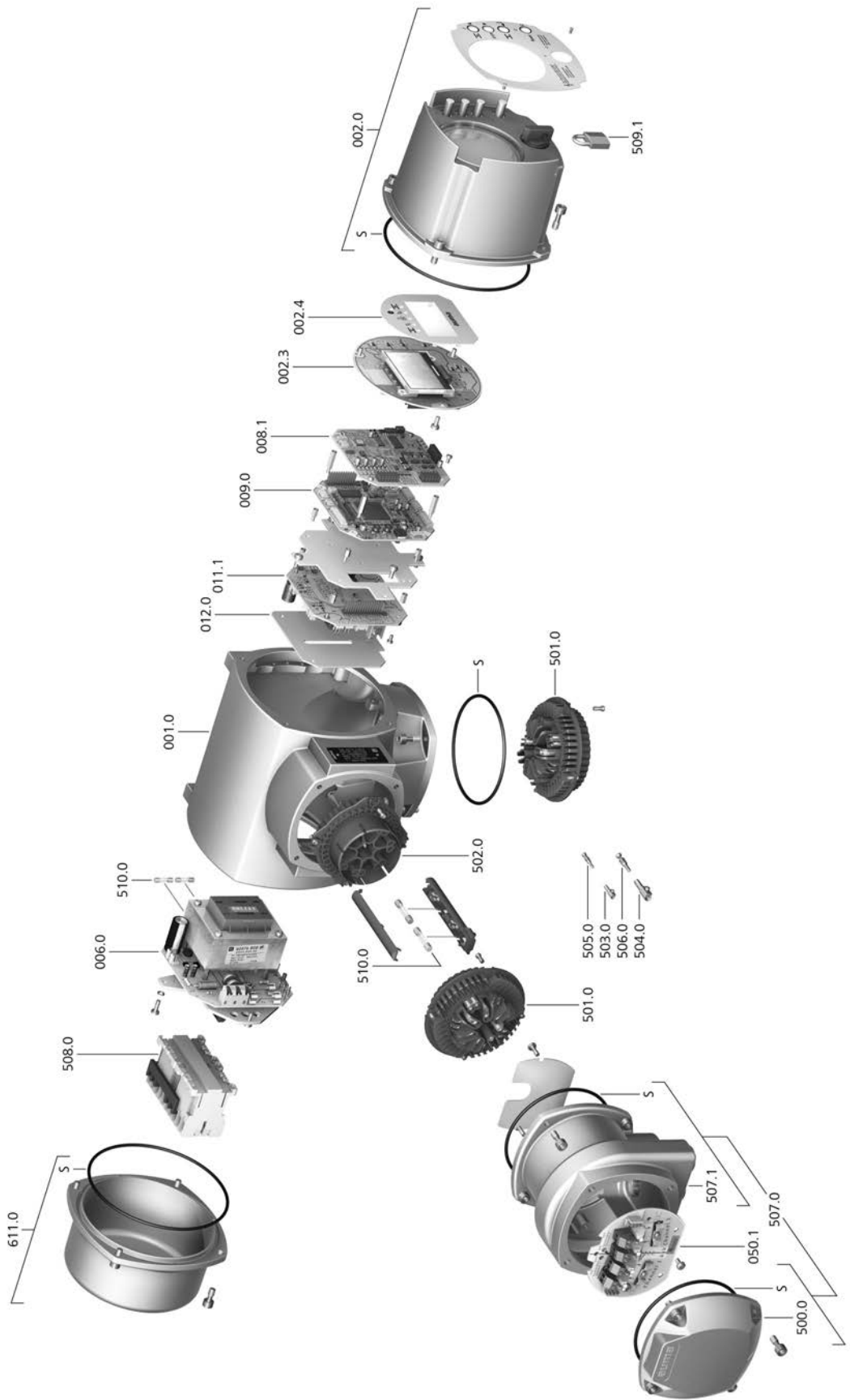

Please state device type and our order number (see name plate) when ordering spare parts. Only original AUMA spare parts should be used. Failure to use original spare parts voids the warranty and exempts AUMA from any liability. Representation of spare parts may slightly vary from actual delivery.

Ref. no.	Designation	Type
001.0	Housing	Sub-assembly
002.0	Local controls	Sub-assembly
002.3	Local controls board	Sub-assembly
002.4	Face plate for display	
006.0	Power supply unit	Sub-assembly
008.1	Fieldbus board	
009.0	Logic board	Sub-assembly
011.1	Relay board	Sub-assembly
012.0	Option board	
050.1	Fieldbus connection board	Sub-assembly
500.0	Cover	Sub-assembly
501.0	Socket carrier (complete with sockets)	Sub-assembly
502.0	Pin carrier without pins	Sub-assembly
503.0	Socket for controls	Sub-assembly
504.0	Socket for motor	Sub-assembly
505.0	Pin for controls	Sub-assembly
506.0	Pin for motor	Sub-assembly
507.0	Electrical connection for fieldbus without connection board (050.1)	Sub-assembly
507.1	Frame for electrical connection	Sub-assembly
508.0	Switchgear	Sub-assembly
509.1	Padlock	Sub-assembly
510.0	Fuse kit	Kit
611.0	Cover	Sub-assembly
S	Seal kit	Set

Index

A

Accessories (electrical connection)	31
Actual value - indication on display	43
Actuator controls terminal plan	10
Actuator operation from remote	35
Actuator terminal plan	10, 11
Ambient temperature	9, 10, 76, 82
Analogue signals	49
Applications	5
Assembly	16
Assistant App	11
AUMA Assistant App	8, 11
AUMA Cloud	8

B

Baud rate	57
Blanking plug	22
Bluetooth	8

C

Cable glands	22
Cables	22
Cable set	31
CDT	8
Coating	82
Colour	82
Commissioning	5
Commissioning (indications on display)	41
Connecting cable	31
Connecting cables	22
Control	10, 11
Control inputs Potential	22
Control voltage	11
Corrective action	66
Corrosion protection	14, 76, 82
Coupling	17, 17
Cross section (fieldbus cable)	23
Current consumption	21
Current type	21

D

Data Matrix code	11
Digital outputs	49
Direct display via ID	37
Direction of rotation	58
Directives	5
Display (indications)	41
Disposal	73
Double sealed	32

E

Earth connection	33
Electrical connection	21
EMC	22
Enclosure protection	9, 10, 10, 76, 82
End stops	51
Error - indication on display	42

F

Failure - indication on display	46
Fault	66
Fault - indication on display	45
Features and functions	80
Fieldbus address	57
Fieldbus cable	23
Fieldbus cables	29
Flange size	11, 11
Frequency range	21
Function check - indication on display	45
Fuses	70

H

Handwheel	16
Heating system	22
Humidity	76

I

Incorrect entry	39
Indication lights	47
Indications	41
Indications on display	41
Indicator disc	47, 61, 64
Indicator mark	48
Input current	11
Input signal	11
Input signals Potential	22
Inspection certificate	11
Installation altitude	82
Insulation class	10
Intermediate frame	32
Intermediate position indication via LEDs	47
Intrusive	7

L

Language in the display	40
LEDs (indication lights)	47
Local actuator operation	34
Local control	34
Local controls	34
Local setting	36
Lubrication	73

M		R	
Main menu	37	Range of application	5
Mains frequency	10, 10	Rated current	10
Mains voltage	10, 10, 21	Rated power	10
Maintenance	5, 73, 73	Recycling	73
Maintenance required - indication on display	46	Reduction gearing reductions	64 22
Manual operation	34	Remote actuator operation	35
Mechanical position indicator	47, 48, 61, 64	Residual current device (RCD)	22
Mechanical position indicator (self-adjusting)	61	Running indication	47, 48
Menu navigation	36	S	
Monitoring time	57	Safety instructions	5
Motor operation	34	Safety instructions/warnings	5
Motor protection	10	Safety measures	22
Motor type	10	Safety standards	22
Mounting position	82	Screw plugs	22
N		Self-retaining	35
Name plate	9	Serial number	9, 10, 11
Non-Intrusive	7	Service	73
Not ready REMOTE - indication on display	45	Servicing	73
O		Setpoint - indication on display	43
Operating the actuator from local controls	34	Short-circuit protection	21
Operating time	9	Signals	49
Operation	5, 34	Signals (analogue)	49
Operation commands - indications on display	43	Size	11
Order number	9, 10, 11	Slave address	57
Out of specification - indication on display	45	Spare parts	84
Output contacts	49	Speed	10
Output signals	49	Standards	5
Output signals Potential	22	Status menu	37
Overvoltage category	77	Status signals	49
P		Status signals Potential	22
Parity	57	Storage	14
Parking frame	32	Supply networks	21
Password	38	Support	73
Password change	39	T	
Password entry	38	Technical data	75
Positioner - indication on display	43	Temperature protection	10
Position indicator	47, 48, 61, 64	Terminal plan	21
Position transmitter	11	Test run	58
Power class	10	Timeout	39
Power class for switchgear	11	Torque - indication on display	42
Power factor	10	Torque range	9
Power supply of electronics	21	Torque switching	54
Protection on site	21	Transport	13
Protective measures	5	Type	11
Push-to-run operation	35	Type designation	9, 10
Q		Type of current	10
Qualification of staff	5	Type of duty	10
		Type of lubricant	9
		Type of networks	21
		U	
		User level	38

Index

V

Valve position - indication on display	42
Vibration resistance	82
Voltage range	21

W

Wall bracket	31
Warnings - indication on display	44
Wire diameter (fieldbus cable)	23
Wiring diagram	11, 21

Y

Year of manufacture	11
Year of production	11



auma[®]

Solutions for a world in motion

AUMA Riester GmbH & Co. KG

P.O. Box 1362

DE 79373 Muellheim

Tel +49 7631 809 - 0

Fax +49 7631 809 - 1250

info@auma.com

www.auma.com